

RSLM

Технические характеристики

По вопросам продаж и поддержки обращайтесь:

Алматы (7273)495-231	Казань (843)206-01-48	Новокузнецк (3843)20-46-81	Смоленск (4812)29-41-54
Архангельск (8182)63-90-72	Калининград (4012)72-03-81	Новосибирск (383)227-86-73	Сочи (862)225-72-31
Астрахань (8512)99-46-04	Калуга (4842)92-23-67	Омск (3812)21-46-40	Ставрополь (8652)20-65-13
Барнаул (3852)73-04-60	Кемерово (3842)65-04-62	Орел (4862)44-53-42	Сургут (3462)77-98-35
Белгород (4722)40-23-64	Киров (8332)68-02-04	Оренбург (3532)37-68-04	Тверь (4822)63-31-35
Брянск (4832)59-03-52	Краснодар (861)203-40-90	Пенза (8412)22-31-16	Томск (3822)98-41-53
Владивосток (423)249-28-31	Красноярск (391)204-63-61	Пермь (342)205-81-47	Тула (4872)74-02-29
Волгоград (844)278-03-48	Курск (4712)77-13-04	Ростов-на-Дону (863)308-18-15	Тюмень (3452)66-21-18
Вологда (8172)26-41-59	Липецк (4742)52-20-81	Рязань (4912)46-61-64	Ульяновск (8422)24-23-59
Воронеж (473)204-51-73	Магнитогорск (3519)55-03-13	Самара (846)206-03-16	Уфа (347)229-48-12
Екатеринбург (343)384-55-89	Москва (495)268-04-70	Санкт-Петербург (812)309-46-40	Хабаровск (4212)92-98-04
Иваново (4932)77-34-06	Мурманск (8152)59-64-93	Саратов (845)249-38-78	Челябинск (351)202-03-61
Ижевск (3412)26-03-58	Набережные Челны (8552)20-53-41	Севастополь (8692)22-31-93	Череповец (8202)49-02-64
Иркутск (395)279-98-46	Нижний Новгород (831)429-08-12	Симферополь (3652)67-13-56	Ярославль (4852)69-52-93
Россия (495)268-04-70	Киргизия (996)312-96-26-47	Казахстан (7172)727-132	

Slim Industrial Relay Type RSLM Electromechanical



- Slim size (width 5mm)
- High breakdown voltage 4kV (between coil and contacts)
- Surge voltage up to 6kV (between coil and contacts)
- Conforms to VDE 0700, 0631 reinforced insulation
- High sensitivity: Approx. 170mW
- RoHS compliant
- Dimensions: 28.0 x 5.0 x 15.0mm
- Changeover contact (SPDT) or Normally Open (SPST) contact configuration option

Product Description

The RSLM is a very slim electromechanical relay that can switch resistive loads with a maximum switching current of 6A. It is available with 1 changeover contact (SPDT) or 1 normally open (SPST) contact.

The RSLM is suitable for use with PLCs, valves actuation or solenoids. The DIN rail installation of the RSLM relays on DIN rail, while the ZRLP enable easy installation on PCB. The DIN rail socket (ZRLS) facilitate the

Approvals



Ordering Key

RSL M 001 024

Model _____
 Type (Electro-mechanical) _____
 Contact configuration _____
 Nominal coil voltage _____

Type Selection

Contact Configuration	Contact Rating	Contact Code
1 change over contact (SPDT - 1)	6A, 250VAC/30VDC	001
1 normally open contact (SPST - 1)	6A, 250VAC/30VDC	100

Selection Guide

Part Number	Max. switching current	Nominal Voltage	Contact Configuration
RSLM100012	6A	12VDC	SPST
RSLM001012			SPDT
RSLM100024		24VDC	SPST
RSLM001024			SPDT
RSLM100048		48VDC	SPST
RSLM001048			SPDT
RSLM100060		60VDC	SPST
RSLM001060			SPDT

Coil Characteristics DC @ +23°C

Nominal Voltage (VDC)	Pick-up Voltage VDC max	Drop-out Voltage VDC min.	Max Voltage VDC ¹⁾	Coil Resistance Ω
12	9.0	0.60	18	848 x (1±10%)
24	18.0	1.20	36	3390 x (1±15%)
48	36.0	2.40	72	10600 x (1±15%)
60	45.0	3.00	90	16600 x (1±15%)

Notes:

- 1) Max voltage refers to the max voltage which the relay coil could endure for a short period of time.
- 2) For products with a rated voltage of ≥ 48V, measures should be taken to prevent the coil overvoltage in order to protect the coil and the application (eg. connect diodes in parallel).
- 3) Do not install RSLM001 types on either of the smallest sides or facing downward.

Contact Characteristics

Contact arrangement	1 Form A (SPST - Normally Open) 1 Form C (SPDT - Changeover)	Electrical endurance 001 (SPST type)	6 x 10 ⁴ OPS (6A 250VAC / 30VDC Resistive load, AgNi, @ 85°C, 1s on 9s off) 3 x 10 ⁴ OPS (NO, 6A 250VAC / 30VDC, Resistive load; AgNi, @ 85°C, 1s on 9s off) 1 x 10 ⁴ OPS (NC, 6A 250VAC/30VDC, Resistive load, AgNi, @ 85°C, 1s on 9s off)
Contact resistance	100mΩ max. (@ 1A 6VDC) Gold plated: 30mΩ max. (@ 1A 6VDC)	100 (SPDT type)	
Contact material	AgNi	Coil power	
Contact rating (Resistive Load)	6A 250VAC / 30VDC	24VDC 48VDC, 60VDC	
Max. switching voltage	400VAC / 125VDC		
Max. switching current	6A		
Max. switching power	1500VA / 180W		
Mechanical endurance	1 x 10 ⁷ OPS		

General Data

Insulation resistance	1000MΩ (@500VDC)	Vibration resistance	10Hz to 55Hz 1mm DA
Dielectric strength		Humidity	5% to 85% RH
Between coil & contacts	4000VAC 1 min	Ambient temperature	-40°C to 85°C
Between open contacts	1000VAC 1 min	Terminal connections	PCB
Operate time	8ms max. (at nominal voltage)	Unit weight	Approx. 5g
Release time	4ms max. (at nominal voltage)	Construction	Plastic sealed, flux proofed
Shock resistance			
Functional	49m/s ²		
Destructive	980m/s ²		

Notes:

- 1) The data shown above is standard
- 2) Please find coil temperature curve in the characteristic curves below
- 3) UL insulation system: Class A

Dimensions

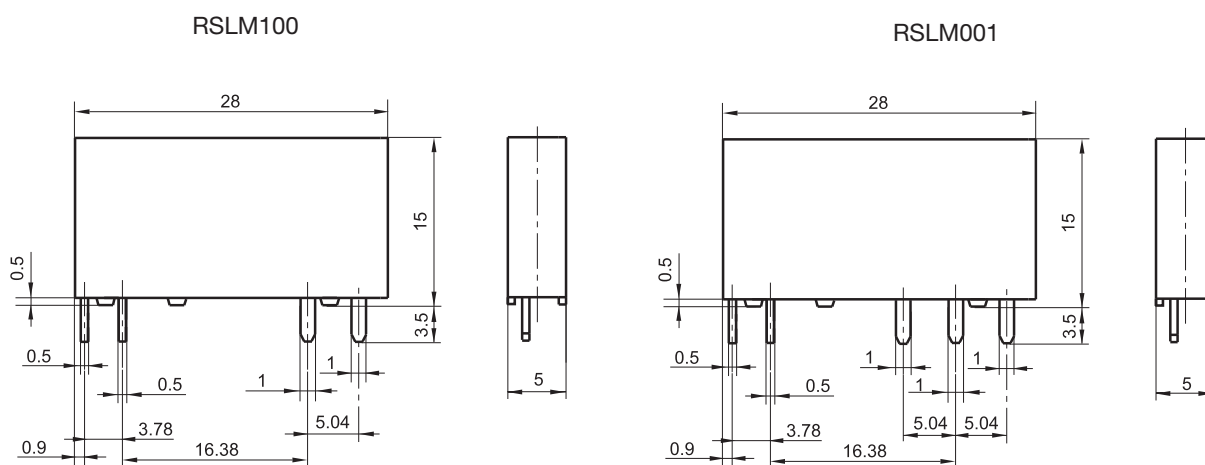

Dimensions

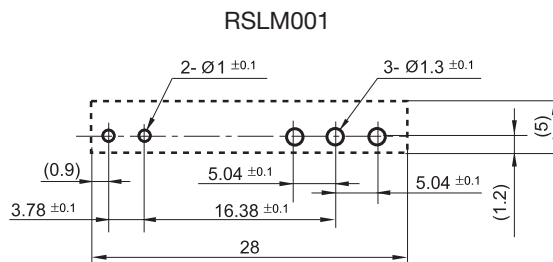
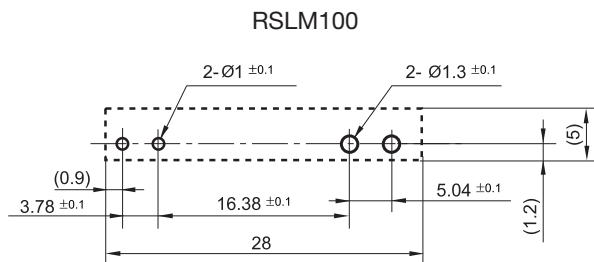

Wiring Diagram

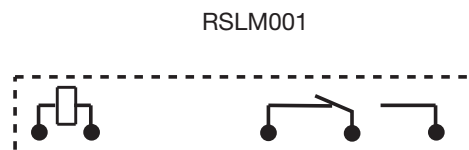
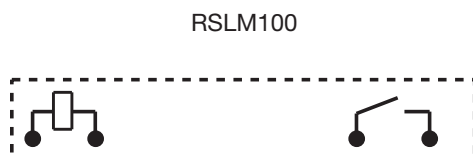

Notes:

Where no tolerance is shown in the dimensional diagram please consider the following tolerances:

- Outline dimension ≤ 1 mm, tolerance should be ± 0.2 mm;
- Outline dimension > 1 mm and ≤ 5 mm, tolerance should be ± 0.3 mm,
- Outline dimension > 5 mm, tolerance should be ± 0.4 mm

Characteristic Curves

MAXIMUM SWITCHING POWER

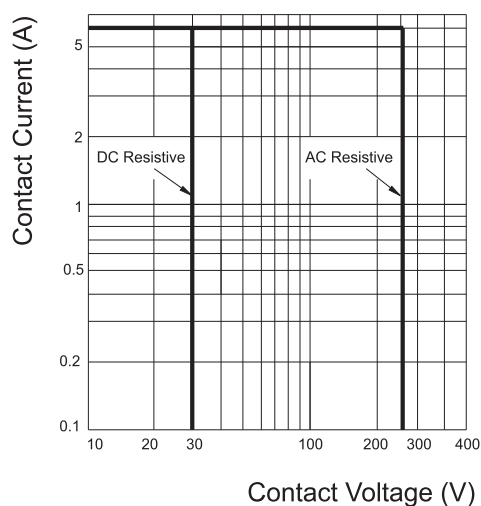

ENDURANCE CURVE

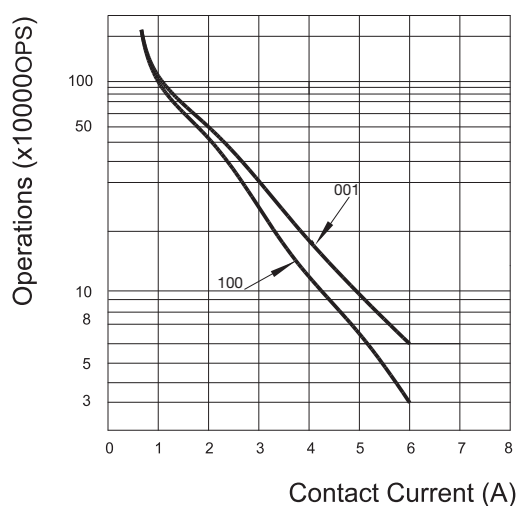

Test conditions:

NO, AgNi, Resistive load, 250VAC,
 Flux proofed, Room temp., 1s on 9s off.

Life Curves

COIL TEMPERATURE RISE

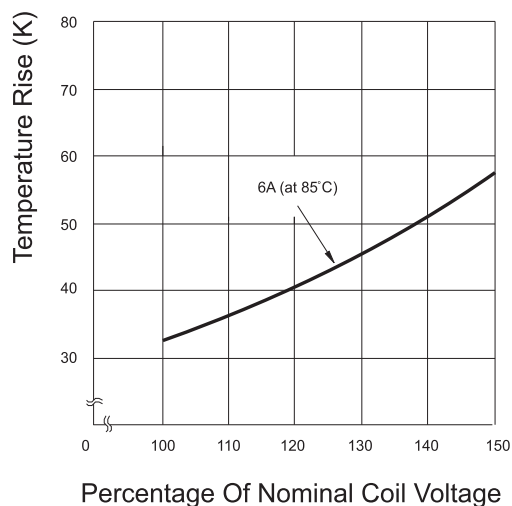

Test conditions:
 6A 85°C
 (Typical curve of 24VDC standard type)

Socket Selection

Relay part number	Socket part number	Socket description
RSLM100012	ZRLS12GA / ZRLS12NA	DIN Rail socket for slim relays 12/24VAC-DC spring DIN Rail socket for slim relays 12/24VAC-DC screw
RSLM001012		
RSLM100024		
RSLM001024		
RSLM100048	ZRLS13GA / ZRLS13NA	DIN Rail socket for slim relays 48/60VAC / DC spring DIN Rail socket for slim relays 48/60VAC / DC screw
RSLM001048		
RSLM100060		
RSLM001060		
RSLM100060 RSLM001060	ZRLS14GA ZRLS14NA ZRLS15GA ZRLS15NA	DIN Rail socket for slim relays 110/125VAC / DC spring DIN Rail socket for slim relays 110/125VAC / DC screw DIN Rail socket for slim relays 220/240VAC / DC spring DIN Rail socket for slim relays 220/240VAC / DC screw

Sockets for RSLM Relays

ZRLS1 NA

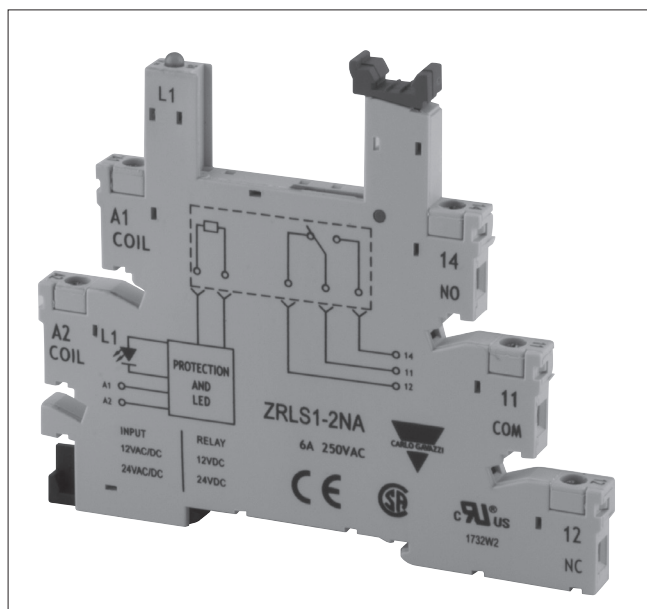

mm/inches DIMENSIONS

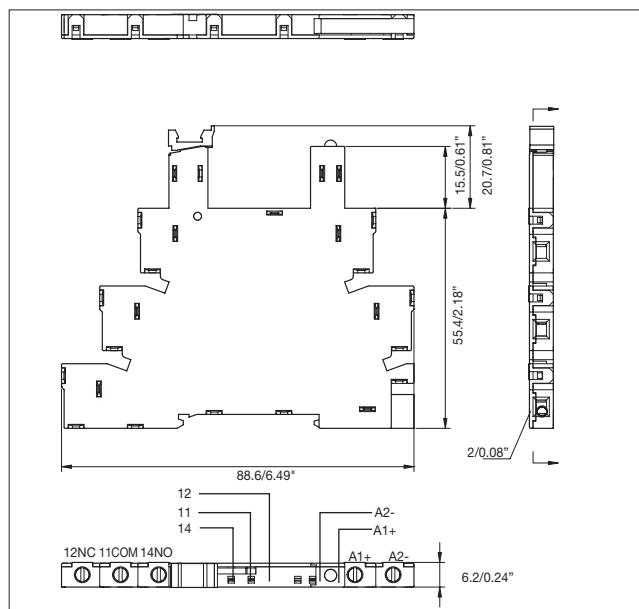

General Data

Rated voltage	250VAC
Rated current	6A
Insulation voltage	>3kV
Protection degree	IP 20 B
Socket material	PA66+GF (V0)
Socket colour	RAL 7035 / Pantone 1C
Contacts material	CuSN 6.5-0.1
Contacts surface	Tin-plated
Terminal type	Screw cage
Operating temperature	-40° to +70°C (-40 to 158°F)
Max wire section	
Flex / Compact wire	2 x 2.5mm (14AWG)
Cable End	2 x 1.5mm (16AWG)

Input data and Ordering code

ZRLS1-2NA	Input	6 to 24VAC/VDC
	Coil rate*	6 to 24VDC
ZRLS1-3NA	Input	48 to 60VAC/VDC
	Coil rate*	48 to 60VDC
ZRLS1-4NA	Input	110 to 125VAC/VDC
	Coil rate*	60VDC
ZRLS1-5NA	Input	220 to 240VAC/VDC
	Coil rate*	60VDC

* The coil rate value is the socket output voltage. The relay to be fitted should have the same coil voltage.

Output Data

Max voltage	300VAC max
Max current	6A

Approvals



Box content: 20 sockets
Box size: 130 x 85 x 95 mm
5.1 x 3.3 x 3.7 inches
Weight: 600g
Weight: 21.16oz

Optional Accessories (to be ordered separately if required)

Labels	ZRLS-LAB
Separator	ZRLS-DIV
Bridging bar	ZRLS-BB

Sockets for RSLM Relays

ZRLS1 GA

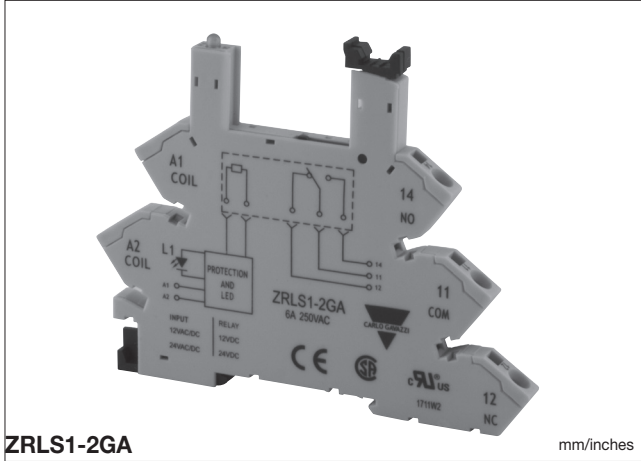

mm/inches DIMENSIONS

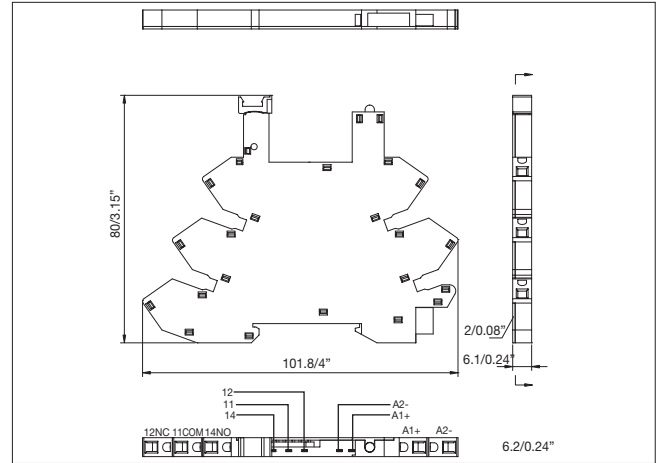

General Data

Rated voltage	250VAC
Rated current	6A
Insulation voltage	>3kV
Protection degree	IP 20 B
Socket material	PA66+GF (V0)
Socket colour	RAL 7035 / Pantone 1C
Contacts material	CuSN 6.5-0.1
Contacts surface	Tin-plated
Terminal type	Spring loaded terminal
Operating temperature	-40° to +70°C (-40 to 158°F)
Max wire section	
Flex / Compact wire	2 x 2.5mm ² (14AWG)
Cable End	2 x 1.5mm ² (16AWG)

Input data and Ordering code

ZRLS1-2GA	Input	6 to 24VAC/VDC
	Coil rate*	6 to 24VDC
ZRLS1-3GA	Input	48 to 60VAC/VDC
	Coil rate*	48 to 60VAC/VDC
ZRLS1-4GA	Input	110 to 125VAC/VDC
	Coil rate*	60VDC
ZRLS1-5GA	Input	220 to 240VAC/VDC
	Coil rate*	60VDC

* The coil rate value is the socket output voltage. The relay to be fitted should have the same coil voltage.

Output Data

Max voltage	300VAC max
Max current	6A

Approvals



Box content:	20 sockets
Box size:	130 x 85 x 95 mm 5.1 x 3.3 x 3.7 inches
Weight:	600g
Weight:	21.16oz

Optional Accessories (to be ordered separately if required)

Labels	ZRLS-LAB
Separator	ZRLS-DIV
Bridging bar	ZRLS-BB

Sockets for RSLM Relays

ZRLP

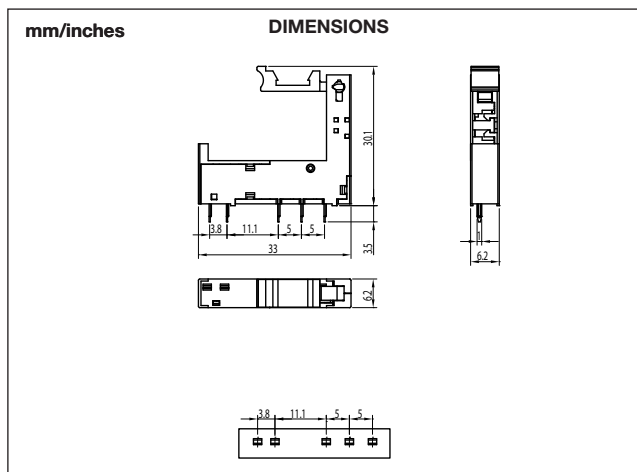
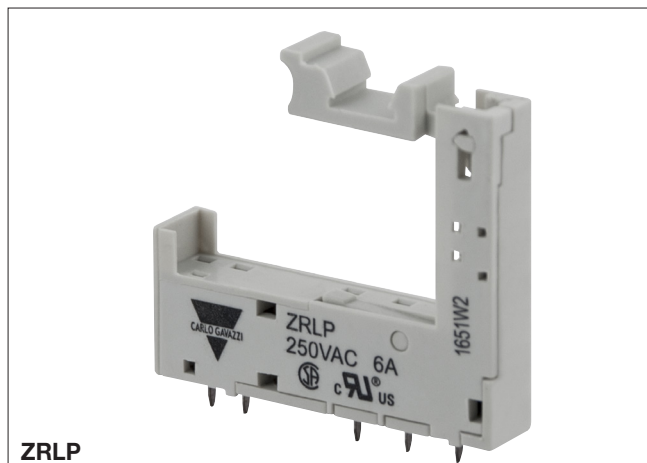

General data

Rated voltage	250VAC
Rated current	6A
Insulation voltage	>3kV
Protection degree	IP 20 B
Socket material	PA66+GF (V0)
Socket colour	RAL 7035 / Pantone 1C
Contacts material	CuSn 6.5-0.1
Contacts surface	tin-plated
Operating temp.	-40° to +70°C (-40° to 158°F)

Ordering Key

ZRLP

* The coil rate value is the socket output voltage. The relay to be fitted should have the same coil voltage.

Output data

Max voltage	300VAC
Max current	6A

Approvals



По вопросам продаж и поддержки обращайтесь:

Алматы (7273)495-231	Казань (843)206-01-48	Новокузнецк (3843)20-46-81	Смоленск (4812)29-41-54
Архангельск (8182)63-90-72	Калининград (4012)72-03-81	Новосибирск (383)227-86-73	Сочи (862)225-72-31
Астрахань (8512)99-46-04	Калуга (4842)92-23-67	Омск (3812)21-46-40	Ставрополь (8652)20-65-13
Барнаул (3852)73-04-60	Кемерово (3842)65-04-62	Орел (4862)44-53-42	Сургут (3462)77-98-35
Белгород (4722)40-23-64	Киров (8332)68-02-04	Оренбург (3532)37-68-04	Тверь (4822)63-31-35
Брянск (4832)59-03-52	Краснодар (861)203-40-90	Пенза (8412)22-31-16	Томск (3822)98-41-53
Владивосток (423)249-28-31	Красноярск (391)204-63-61	Пермь (342)205-81-47	Тула (4872)74-02-29
Волгоград (844)278-03-48	Курск (4712)77-13-04	Ростов-на-Дону (863)308-18-15	Тюмень (3452)66-21-18
Вологда (8172)26-41-59	Липецк (4742)52-20-81	Рязань (4912)46-61-64	Ульяновск (8422)24-23-59
Воронеж (473)204-51-73	Магнитогорск (3519)55-03-13	Самара (846)206-03-16	Уфа (347)229-48-12
Екатеринбург (343)384-55-89	Москва (495)268-04-70	Санкт-Петербург (812)309-46-40	Хабаровск (4212)92-98-04
Иваново (4932)77-34-06	Мурманск (8152)59-64-93	Саратов (845)249-38-78	Челябинск (351)202-03-61
Ижевск (3412)26-03-58	Набережные Челны (8552)20-53-41	Севастополь (8692)22-31-93	Череповец (8202)49-02-64
Иркутск (395)279-98-46	Нижний Новгород (831)429-08-12	Симферополь (3652)67-13-56	Ярославль (4852)69-52-93
Россия (495)268-04-70	Киргизия (996)312-96-26-47	Казахстан (7172)727-132	

cgo@nt-rt.ru || <https://gavazzi.nt-rt.ru/>