

VMU

Технические характеристики

По вопросам продаж и поддержки обращайтесь:

Алматы (7273)495-231
Архангельск (8182)63-90-72
Астрахань (8512)99-46-04
Барнаул (3852)73-04-60
Белгород (4722)40-23-64
Брянск (4832)59-03-52
Владивосток (423)249-28-31
Волгоград (844)278-03-48
Вологда (8172)26-41-59
Воронеж (473)204-51-73
Екатеринбург (343)384-55-89
Иваново (4932)77-34-06
Ижевск (3412)26-03-58
Иркутск (395)279-98-46
Россия (495)268-04-70

Казань (843)206-01-48
Калининград (4012)72-03-81
Калуга (4842)92-23-67
Кемерово (3842)65-04-62
Киров (8332)68-02-04
Краснодар (861)203-40-90
Красноярск (391)204-63-61
Курск (4712)77-13-04
Липецк (4742)52-20-81
Магнитогорск (3519)55-03-13
Москва (495)268-04-70
Мурманск (8152)59-64-93
Набережные Челны (8552)20-53-41
Нижний Новгород (831)429-08-12
Киргизия (996)312-96-26-47

Новокузнецк (3843)20-46-81
Новосибирск (383)227-86-73
Омск (3812)21-46-40
Орел (4862)44-53-42
Оренбург (3532)37-68-04
Пенза (8412)22-31-16
Пермь (342)205-81-47
Ростов-на-Дону (863)308-18-15
Рязань (4912)46-61-64
Самара (846)206-03-16
Санкт-Петербург (812)309-46-40
Саратов (845)249-38-78
Севастополь (8692)22-31-93
Симферополь (3652)67-13-56
Казахстан (7172)727-132

Смоленск (4812)29-41-54
Сочи (862)225-72-31
Ставрополь (8652)20-65-13
Сургут (3462)77-98-35
Тверь (4822)63-31-35
Томск (3822)98-41-53
Тула (4872)74-02-29
Тюмень (3452)66-21-18
Ульяновск (8422)24-23-59
Уфа (347)229-48-12
Хабаровск (4212)92-98-04
Челябинск (351)202-03-61
Череповец (8202)49-02-64
Ярославль (4852)69-52-93

Energy Management BUS Adapter Type VMU-B M2

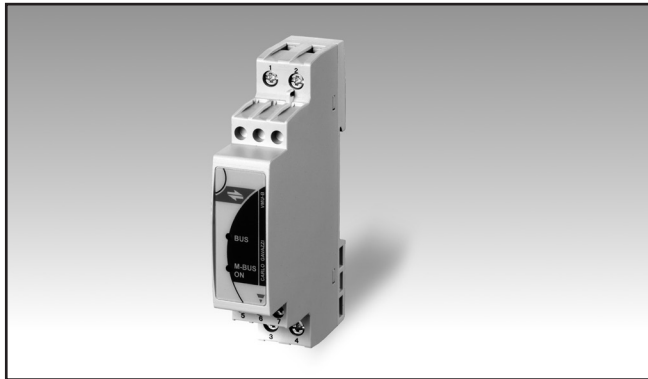

- RS485 Modbus to M-Bus communication adapter
- EM210, EM26 self recognition (option A)
- EM270, EM271 and EM280 self recognition (option B)
- WM15 self recognition (option C)
- Front diagnostic LED's
- Universal 18 to 260 VAC/DC power supply
- Dimensions: 1-DIN module
- Protection degree (front): IP40

Product Description

RS485 Modbus to M-Bus compact adapter. The module is provided with universal power supply and is able to recognize and auto-set the variable format and mapping according to the connected Carlo Gavazzi instrument. Housing for DIN-rail mounting, IP40 (front) protection degree.

How to order

VMU-B M2 U S1B1 B

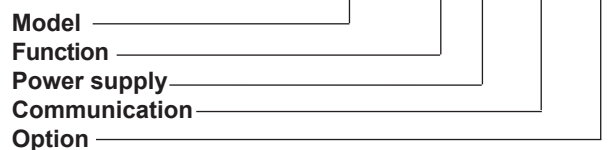

Type Selection

Function	Power supply	Communication	Option
M2: M-Bus port according EN13757-3:2013	U: From 18 to 260VAC/DC	S1B1: RS485 Modbus to M-Bus	A: EM210, EM26 compatible B: EM270, EM271, EM280 compatible C: WM15 compatible

Communication

LED 1	Amber. ON steady light: working communication on RS485 bus; Blinking light: not working communication on RS485 bus.		light: M-bus communication with the unit. Both AMBER and GREEN LED OFF light: the module is not power supplied.
LED 2	Green. When M-Bus communication is not available (during the instrument starting) the LED blinks according to the set baudrate: 300 bps: blinking, pause; 2400 bps: blinking, blinking, pause; 9600 bps: blinking, blinking, blinking, pause. ON steady light: NO M-bus communication with the VMU-B unit. ON blinking	RS485 Function Type Connections Addresses Protocol Boud-rate Data format	Master function One-drop, bidirectional 3-wire The wires are already screwed on the three screw terminals (wire length: 10 cm). Max. distance 1000 m 247, set automatically by the connected instrument downstream the bus. MODBUS/JBUS (RTU) According to the communication speed set in the connected meter. According to the connected instrument.



Communication (cont.)

Frame format	According to the connected instrument, see table "Converted variables"	Baud-rate	300 to 9600 bits/s (set automatically by the M-Bus master)
Special functions	None	Data format	According to the connected instrument.
Insulation	By means of optocouplers, 4000 VRMS between communication port to power supply input. No insulation between RS485 port and M-Bus communication port.	Frame format	According to the connected instrument, see relevant protocol
M-Bus		Special functions	None
Function	Slave function	Insulation	By means of optocouplers, 4000 VRMS between communication port to power supply input. No insulation between RS485 port and M-Bus communication port.
Type	One-drop, bidirectional		
Connections	2-wire.		
Addresses	247, set automatically by the connected instrument downstream the bus.		
Protocol	M-Bus according to EN13757:2013		

General specifications

Operating temperature	-25°C to +55°C (-13°F to 131°F) (R.H. from 0 to 90% non-condensing @ 40°C)	Immunity to conducted disturbances	10V/m from 150KHz to 80MHz
Storage temperature	-30°C to +70°C (-22°F to 158°F) (R.H. < 90% non-condensing @ 40°C)	Surge	2kV on power supply;
Installation category	Cat. III (IEC60664, EN60664)	Radio frequency suppression	According to CISPR 22
Insulation (for 1 minute)	4000 VRMS between communication BUS and power supply	Standard compliance	
Dielectric strength	4000 VRMS for 1 minute	Safety	IEC60664, IEC61010-1 EN60664, EN61010-1
Noise rejection		Approvals	CE
CMRR	100 dB, 48 to 62 Hz	Connections	Screw-type
EMC	According to: EN61000-6-2 (industrial immunity) and EN61000-6-3 (light industry emission).	Cable cross-section area	Min. 2.5 mm ² , Max. 6 mm ² Min./Max. screws tightening torque: 0.5 Nm / 1.1 Nm Other terminals: 1.5 mm ² ; Min./Max. screws tightening torque: 0.4 Nm / 0.8 Nm
Electrostatic discharges	8kV air discharge;	DIN Housing	
Immunity to irradiated electromagnetic fields	Test with applied current: 10V/m from 80 to 2000MHz; Test without any applied current: 30V/m from 80 to 2000MHz;	Dimensions (WxHxD)	17.5 x 90 x 67.5 mm
	On current and voltage measuring input circuits: 4kV	Material	Nylon PA66, self-extinguishing: UL 94 V-0 DIN-rail
Burst		Mounting	
		Protection degree	
		Front	IP40
		Screw terminals	IP20
		Weight	Approx. 100 g (packing included)

Power supply specifications

Power supply	18 to 260 VAC/DC	Power consumption	≤ 3VA
--------------	------------------	-------------------	-------

Insulation between inputs and outputs

	RS485 port	M-Bus port	Power supply
RS485 port	-	0kV	4kV
M-Bus port	0kV	-	4kV
Power supply	4kV	4kV	-

Wiring diagrams

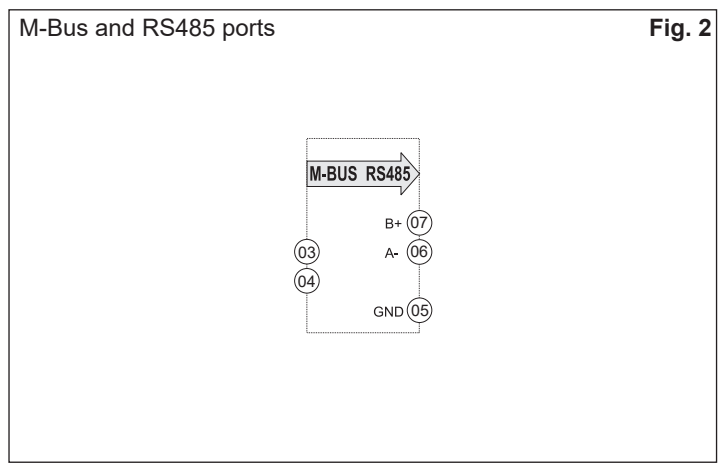
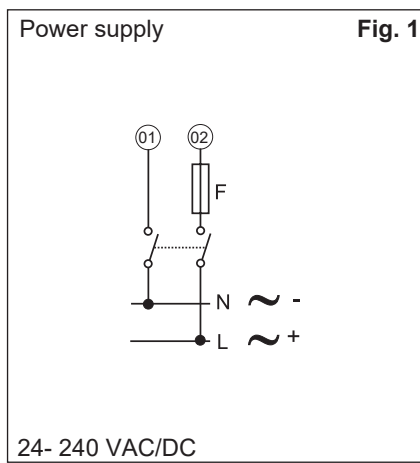
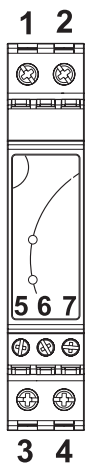

Frontal panel description

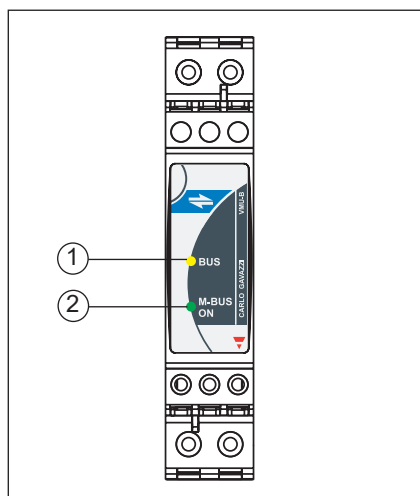

1. **Amber LED.** ON steady light: working communication on RS485 bus;
Blinking light: not working communication on RS485 bus.

2. **Green LED.** When M-Bus communication is not available (during the instrument starting) the LED blinks according to the set baudrate:
300 bps: blinking, pause;
2400 bps: blinking, blinking, pause;
9600 bps: blinking, blinking, blinking, pause.
ON steady light: NO M-bus communication with the VMU-B unit.
ON blinking light: M-bus communication with the unit.
Both AMBER and GREEN LED OFF light: the module is not power supplied.

Dimensions and panel cut-out

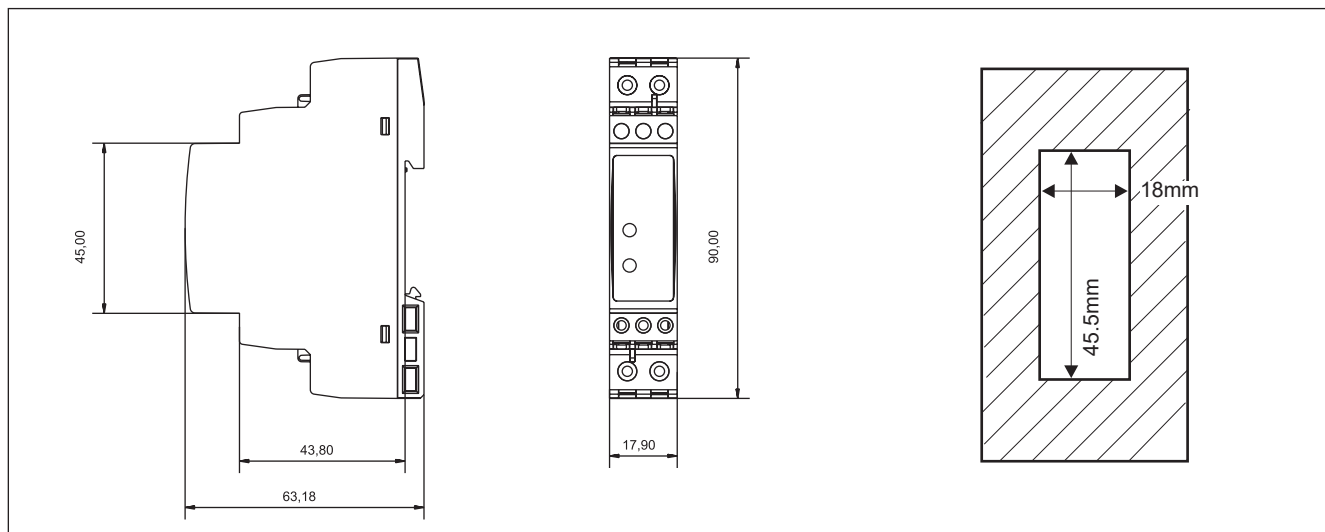

VMU-C EM system



Integrated modular system to monitor conventional energy



Description

VMU-C EM is a modular system that records, monitors and transmits analog and digital signals from an industrial, commercial or residential installation with a specific focus on energy efficiency.

The system includes a web server with a powerful and intuitive user interface to monitor data and set up the system.

Data can be transmitted using various protocols (FTP, HTTP, Modbus TCP/IP) and via wired or wireless connection.

Benefits

- **Integrated system.** The system is a package of integrated modules. The main module includes the web server with a web interface to monitor and set up the system.
- **Integrated Software.** No subscriptions or additional services are required.
- **Fast, easy and free updates.** Integrated software updates can be easily downloaded and installed via web interface, without losing data and without additional fees.
- **Communication flexibility.** The system transmits data (to CARLO GAVAZZI's or third party systems) via various communication protocols (FTP, HTTP, Modbus TCP/IP).
- **Scalability.** The system can be progressively integrated with new modules according to application needs.
- **Fast installation and set-up.** The entire system is installed and set up via web interface.
- **Reliability.** The system is secure against cyber attacks and computer viruses. Data redundancy and backup tools prevent information losses.
- **High monitoring capacity.** The system manages up to 100 meters, analog and digital inputs.
- **High recording capacity.** The system records data and events for a system for up to 30 years.
- **Compact size.** The maximum module package dimension is 8-DIN. Note: max number of energy meters depends on the meter type; check the table "VMU accessory modules and meters".
- **IoT Ready.** VMU-C EM is "Microsoft Azure Certified for IoT".

Applications





It is ideal for scenarios where ease of use, scalability, data resilience and long-term reliability are essential. Given the type of industrial hardware, compact size and low energy consumption, it can be installed in both industrial and residential environments.

Main functions

- Monitor energy control systems so as to check energy efficiency status and improvements.
- Record and display information.
- Transmit collected data.
- Manage alarms.

▶ VMU-C EM system modules

VMU-C EM system modules are:

Symbol	Name	Description
	VMU-C EM	Main module made up of a micro PC pre-installed with a web server. Communicates via various communication protocols. Monitors and records information and alarms. Transmits data supplied from energy meters and VMU-O EM and VMU-P EM accessory modules. One VMU-C EM module per system.
	VMU-M EM	Accessory module that controls VMU-O EM and VMU-P EM modules. Records and manages data provided by the modules. Maximum 10 VMU-M EM modules per system.
	VMU-O EM	Accessory module for digital inputs and outputs. Maximum 33 VMU-O EM modules per system.
	VMU-P EM	Accessory module for analog inputs. Maximum 11 VMU-P EM modules per system.
	VMU-D	Accessory module for mobile wireless transmission. One VMU-D module per system.

VMU-C EM system architecture (configuration maximums)

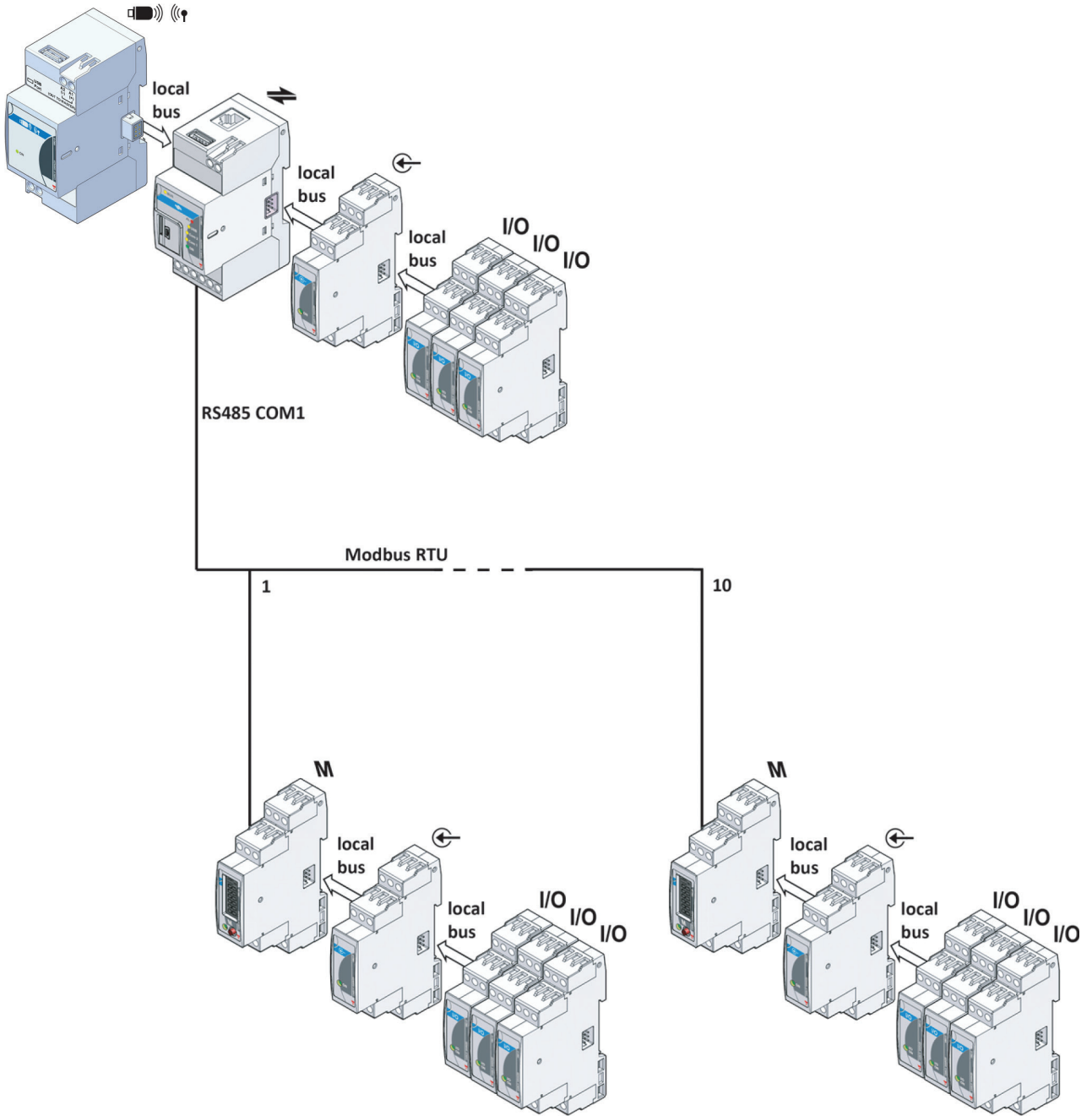

VMU-C EM system communication architecture (inputs and outputs)

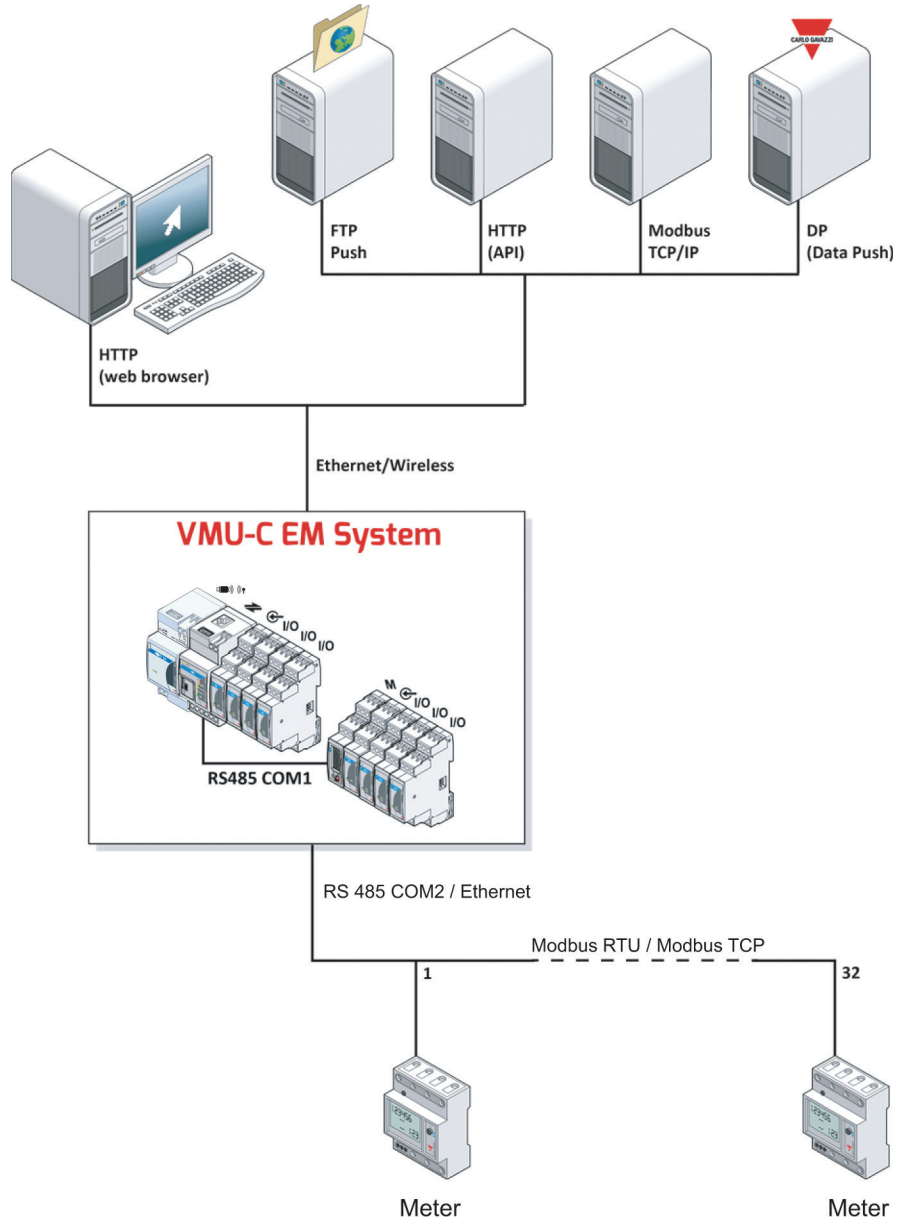



Features

General

Material	Noryl, self-extinguishing V-0 (UL94)
Assembly	DIN rail
Protection grade	Front: IP40, Terminals: IP20
Terminals	Section: 1.5 mm ² maximum; Torque: 0.4–0.8 Nm
Over voltage category	Cat. III (IEC 60664)
Rejection (CMRR)	>65 dB, from 45 to 65 Hz

Environmental

Working temperature	From -25 to +55 °C/ from -13 to +149 °F (relative humidity <90% without condensation @ 40 °C/104 °F). If at least one VMU-O EM module is installed, check "Working temperature with VMU-O EM module" below.
Assembly Storage temperature	From -30 to +70 °C / from -22 °F to +158 °F (relative humidity <90% without condensation @ 40 °C / 104 °F).

Note: R.H. < 90% non-condensing @ 40°C (104°F)

Working temperature with VMU-O EM module

The maximum VMU-O EM module input current affects its connected module working temperatures.

Maximum current VMU-O EM [A]	Working temperature	
	[°C]	[°F]
2.5	From -25 to +55	From -13 to +149
3	From -25 to +55	From -13 to +149
3.5	From -25 to +55	From -13 to +149
4	From -25 to +50	From -13 to +122
5	From -25 to +40	From -13 to +104

Compatibility and conformity

Electromagnetic compatibility (EMC) - immunity	Reference: EN61000-6-2 Electrostatic discharges: EN61000-4-2: 8kV air discharge, 4kV contact Immunity to irradiated electromagnetic fields EN61000-4-3: 10V/m from 80 to 3000MHz Immunity to Burst EN61000-4-4: 4kV on power lines, 2kV on signal lines Immunity to conducted disturbances: EN61000-4-6: 10V from 150KHz to 80MHz Surge: EN61000-4-5: 500V on power supply.
Electromagnetic compatibility (EMC) - emissions	Radio frequency suppression: EN61000-6-3, CISPR 22, class B
Approvals	

VMU-C EM main module

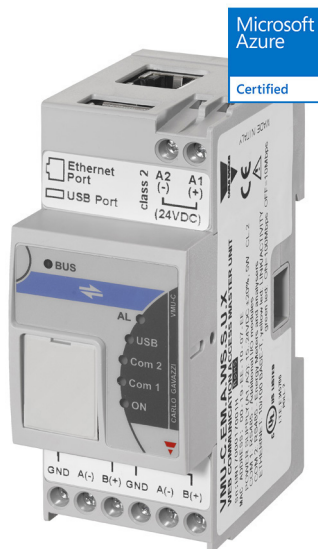

Description

VMU-C EM is the main VMU-C EM system module. It is a micro PC pre-installed with a web server with pages viewable via browser. It monitors the system, recording and transmitting energy meters data. It communicates via various communication protocols (FTP, HTTP, Modbus TCP/IP) in wired connection. If connected to the dongle modem (VMU-D module + USB dongle modem) it also communicates via wireless 3G mobile network. If set in the system, it controls modules to manage analog variables (VMU-P) and digital inputs and outputs (VMU-O). Control can be direct via local bus or indirect via Modbus RTU serial communication with the VMU-M EM module.

Main features

- Micro-PC with web server
- Adaptive database according to connected meters (up to 100 meters)
- Managed variables: DC and AC electrical variables (kWh, kvarh, kW, kvar, kVA, V, A), THD, PF
- Other managed data: analogue variables, digital inputs/outputs, utility meters and totalizers
- Local storage of system data and event for up to 30 years
- Backup on external devices
- Communication ports: RS485 Modbus RTU, Ethernet, local bus, mini-USB
- Supported protocols: FTP, DP(Data Push), HTTP, Modbus TCP/IP, SMTP
- Friendly user interface accessible via standard web browser
- Free integrated software updates, easy to download and install via web interface
- 2-DIN size
- **IoT Ready.** VMU-C EM is "Microsoft Azure Certified for IoT".

Main functions

- Record and display meters and accessory module data
- Monitor data according to user needs
- Manage alarms
- Transmit logged data to external systems on the local or distributed network
- Set up the entire system

Structure

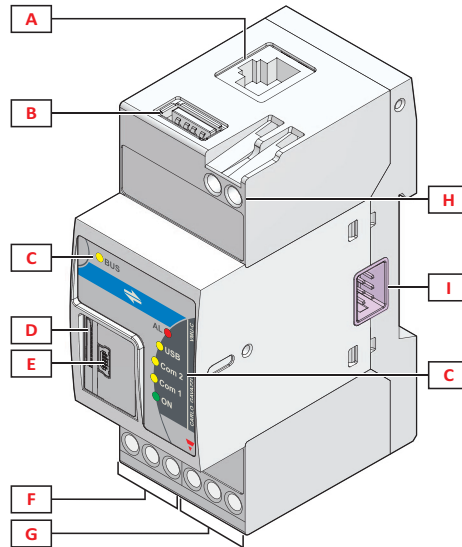

Element	Component	Function
A	Ethernet port	Displaying the web interface and transmitting data to remote systems via wired connection
B	USB Port (Host function)	Permitting data backup on USB flash drive (not supplied)
C	Information LED	Indicating the following statuses: local bus connection (BUS) alarms (AL) USB key (USB) RS485 COM1 port (COM1) RS485 COM2 port (COM2) module power and backup to Micro SD (On)
D	Micro SD memory card slot	Permitting data backup to Micro SD (not supplied)
E	Mini-USB port (Device function)	Connecting a PC to view the web interface if there are connection problems via Ethernet port and permitting backup to PC
F	RS485 COM1 port terminals	Connecting VMU-M EM accessory modules
G	RS485 COM2 port terminals	Connecting meters and analyzers
H	Power terminals	Powering the module
I	Local bus port (left side and right side)	Left side: connecting the VMU-D accessory module to the local bus. Right side: connecting VMU-P EM or VMU-O EM accessory modules to the local bus.

Features

General

Operating system	Linux
Dimensions	2-DIN
Weight	< 600 g (packaging included)
Mean time to failure	MTTF/MTBF: 12 years. Test conditions: gf (ground, fixed), 50 °C. Standard: MIL-DBK-217F

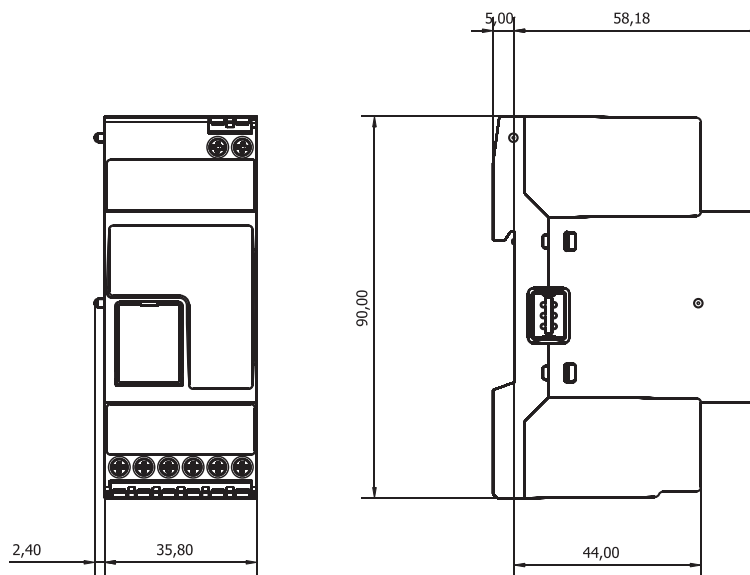

Power Supply

Power Supply	12–28 VDC
Consumption	≤ 5 W
Battery	1 Metal-ion non-replaceable battery; 0.04 g

Note: The device contains metal-ion batteries. For the sending, you must comply with the relevant packaging and labelling regulation.

Power supply sizing guidelines based on the connected optional modules are reported in the following table.

VMU-O EM (quantity)	VMU-P EM *(quantity)	VMU-D (quantity)	Consumption (W)	Start-up current (A)	Power supply order code
0	0	0	2.5	4.5 for 1s	18 W: SPD 24 18 1B; 30 W: SPM3 24 1
≤ 1	≤ 1	0	5	6 for 1s	18 W: SPD 24 18 1B; 30 W: SPM3 24 1
2 or 3	≤ 1	1	10.6	13 for 1s	60 W: SPD 24 60 1B; SPM4 24 1

Note *: CARLO GAVAZZI wind sensor consumption (code DWS-V) included.
 Note: one VMU-C EM module consumption included.

Input/output isolation

Type	Power	RS485 COM1	RS485 COM2	Ether-net	USB	Mini-USB	Local Bus (VMU-D)	Local bus (VMU-P/O)	VMU-P inputs	VMU-O digital inputs	VMU-O relay output
Power	-	2	2	0.5	0	0	0	0	0	0	4
RS485 COM1	2	-	0.5	2	2	2	2	2	2	2	4
RS485 COM2	2	0.5	-	2	2	2	2	2	2	2	4
Ether-net	0.5	2	2	-	0.5	0.5	0.5	0.5	0.5	0.5	4
USB	0	2	2	0.5	-	0	0	0	0	0	4
Mini-USB	0	2	2	0.5	0	-	0	0	0	0	4
Local bus (VMU-D)	0	2	2	0.5	0	0	-	0	0	0	4
Local bus (VMU-P/O)	0	2	2	0.5	0	0	0	-	0	0	4
VMU-P inputs	0	2	2	0.5	0	0	0	0	-	0	4
VMU-O digital inputs	0	2	2	0.5	0	0	0	0	0	-	4
VMU-O relay output	4	4	4	4	4	4	4	4	4	4	-

Key

- **0:** inputs/outputs are not insulated.
- **0.5:** 0.5kV rms isolation (functional insulation).
- **2:** 2 kV rms isolation (EN 61010-1, IEC 60664-1, Over voltage category III, pollution grade 2, double isolation on system with maximum 300Vrms to ground).
- **4:** EN61010-1, IEC60664-1 - Over-voltage category III, Pollution degree 2, double insulation on systems with max. 300Vrms to ground

Ports

Ethernet

Standard	ISO9847
Protocols	HTTP, SFTP, Modbus TCP/IP, DP (Data Push), SMTP, JNTP
Client connection	Maximum 20 simultaneous client connections (one administrator at a time)
Connection type	RJ45 connector (10 Base-T, 100 Base-TX); maximum distance: 100 m

Auxiliary bus

Communication function	Master
Compatibility	Right side: VMU-P EM or VMU-O EM accessory modules Left side: VMU-D accessory module

USB

Type	High speed USB, 2.0 - A (250 mA maximum)
Mode	Hot swap
Communication speed	60 MB/s
Function	<ul style="list-style-type: none"> "H" - Host Permitting internal database backup. Windows 7 and Windows 10 driver download (required to access the web server via mini-USB port).
Terms of use	Can be used in parallel with mini-USB port. Cannot be used if the VMU-D accessory module is already connected and enabled.

Micro SD slot

Type	Industrial (from -25 to +85 °C / -13 to + 185 °F) - not supplied
Capacity	SD: up to 2 GB SDHC: 4–16 GB
Function	Permitting internal database backup.

Mini-USB

Type	High speed USB 2.0 - mini
Mode	Hot swap
Speed	60 MB/s
Function	<ul style="list-style-type: none"> "D" Devices Accessing the web interface without Ethernet connection* Configuring the system, updating firmware, and downloading measured data and events.
Condition of use	Can be used in parallel with USB port. Cannot be used if the VMU-D accessory module is already connected.

Note*: this requires a specific driver be installed on the PC. The driver is automatically downloaded by the module the first time a USB key is connected. This procedure is required for PC with operating system up to



Windows 7 and Windows 10. Available as a standard driver with Windows 8.

RS485

COM1 port	Maximum 10 VMU-M EM accessory modules
COM2 port	Maximum 100 meters*
Communication type	Multidrop, two-way (static and dynamic variables)
Connection type	2 wires, maximum distance 1000m (with repeater)
Protocol	MODBUS/JBUS (RTU)
Data	All
Data format	Selectable: 1 start bit, 7/8 data bits, no/even/odd parity, 1/2 stop bits
Transmission speed	Selectable: 9.6kbps / 19.2kbps / 38.4kbps / 115.2kbps
Driver input capability	1/8 unit load. Maximum 256 nodes on a network

* The maximum number of meters depend on the meters' type (1-phase, 3-phase) and configuration.

Connected meter limits

Type of Meter	Max Meter	History log interval(months) Vs. data granularity(minutes)*		
		5 minutes	10 minutes	15 minutes
1-phase meters (10 variables)	100	5	10	15
1-phase meters (20 variables)	50	6	13	23
3-phase meters (15 variables)	64	6	12	18
3-phase meters (30 variables)	32	8	17	25
DC meters (4 variables)	100	6	15	23
EM270 family (6.1P configuration)	10	6	12	18
EM270 family (3.2P configuration)	16	6	12	18

Note*: the history log interval will automatically increase if less meter than the maximum are connected.



Data recording

Recording on internal memory

RAM	128MB
Flash	4 GB available for variables, configurations, variables, alarms and events. FIFO storage window depending on the managed datapoints (1)
Recorded information	Meter variables and accessory module analogue inputs (see Data management See page 13) Alarm on variables' set-points Status change of accessory modules, power supply and I/Os System configuration XML driver to read external devices Firmware update file
Variable recording mode	The system calculates the average, minimum, maximum values of the measured variables in a time interval and saves it. Three interval ranges are available: a) maximum granularity (1-60 minutes) ; FIFO dynamically managed (e.g. 8 months with 32 3-phase meters) b) daily granularity; up to 30 years of storage c) monthly granularity; up to 30 years of storage
Event and alarm recording mode	Events and alarms are always recorded one by one.

Notes: (1) see table "Connected meter limits"

Data backup via external devices

External devices can be connected to back up internal memory data. Backup is automatic and daily. The following table displays the available information Vs. the external device in use.

Note: if several external devices are connected, the Micro-SD takes priority.

Operation	Information	Micro-SD	USB key	PC via mini-USB
Download (from VMU-C EM)	Variables, alarms and events	x *	x *	x *
	System configuration	x	x	x
	Driver for PC access to the web server via mini-USB	x	x	-
Upload (to VMU-C EM)	Variables, alarms and events	x *	x *	-
	System configuration	x	x	x
	XML driver to read external devices (i.e. energy meters)	-	-	x
	Firmware update	-	-	x

Note*: full database is saved in proprietary format; weekly report is saved in HTML format compatible with Excel or other spreadsheets.

Data management

Management and transmission modes

Meter variables are collected by the main VMUC EM module via RS485 COM2 port and recorded in the internal memory for being then transmitted and viewed remotely. I/O variables and conditions are transmitted to the main VMU-C EM module via local bus or RS485 COM1 port based on system architecture. Data from accessory modules connected to the VMU-M EM module local bus are recorded in the internal VMU-M EM memory and then transmitted to VMU-C EM. All data are recorded in the internal VMU-C EM main module memory for being then transmitted and viewed remotely.

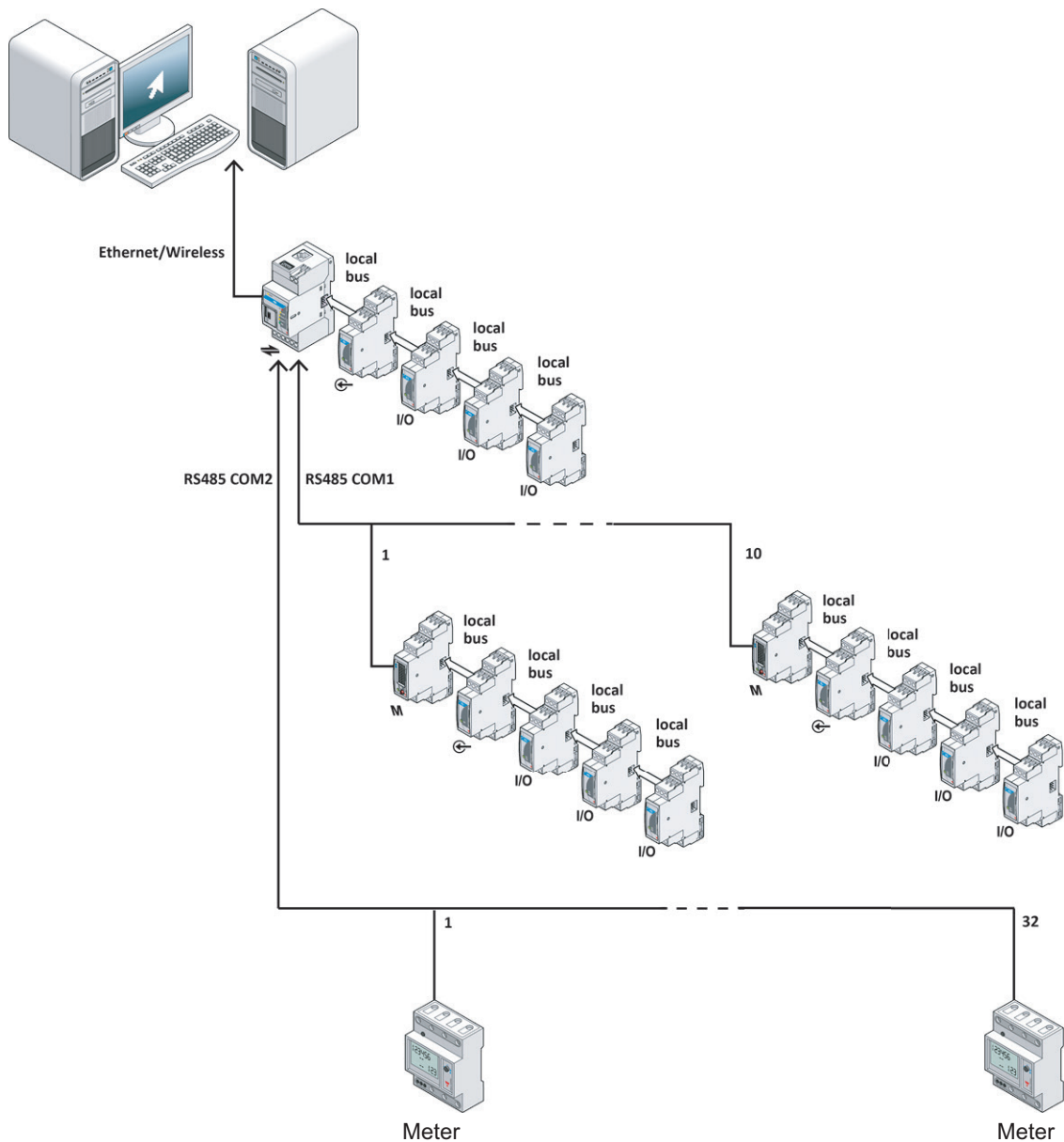

Meter variables transmission modes

Variables		Transmission				
		HTTP (web browser)	FTP	Modbus TCP/IP	HTTP (API)	Data Push
Active Energy	kWh	X	X	X	X	X
Active Energy per tariff	kWh per tariff*	X	-	-	-	-
Reactive Energy	kvarh	X	X	X	X	X
Reactive Energy per tariff	kvarh per tariff*	X	-	-	-	-
Phase voltage	V, V L-N sys, V L1-N, V L2-N, V L3-N	X	X	X	X	X
Mains voltage	V L-L sys, V L1-L2, V L2-L3, V L3-L1	X	X	X	X	X
Current	AL1, AL2, AL3	X	X	X	X	X
Active power	kW, kW sys, kW L1, kW L2, kW L3	X	X	X	X	X
Reactive power	kvar sys, kvar L1, kvar L2, kvar L3	X	X	X	X	X
Apparent power	kVA sys, kVA L1, kVA L2, kVA L3	X	X	X	X	X
Average power required	W dmd *	-	-	-	-	X
Maximum power required	W dmd max	-	-	-	-	X
Power factor*	PF sys, PF L1, PF L2, PF L3	X	X	X	X	X
Phase sequence	Phase sequence	X	X	X	X	X
Frequency	Hz	X	X	X	X	X
THD in current	THD A L1, THD A L2, THD A L3	X	X	X	X	X
THD in voltage	THD V L1-N, THD V L2-N, THD V L3-N	X	X	X	X	X
Utility meters (i.e. water, gas)	Totalizer	X	X	X	X	X

Note*: measure calculated by VMU-C EM based on other measurements or configuration parameters.

Meter operating modes

The VMU-C EM manages a single total meter (main meter) and several partial meters. The system automatically sets a virtual one that acts at the system total meter. You can set whether or not each partial meter contributes to the main virtual meter.



▶ Transmission method for I/Os variables and conditions

Information	Transmission				
	HTTP (web browser)	FTP	Modbus TCP/IP	HTTP (API)	Data Push
Temperature 1 (VMU-M EM / VMU-P EM)	X	X	X	X	X
Temperature 2 (VMU-M EM / VMU-P EM)	X	X	X	X	X
Analog input (VMU-P EM)	X	X	X	X	X
Pulse speed input (VMU-P EM)	X	X	X	X	X
Output On/Off status alerting (VMU-O EM)	X	X	-	X	X
System status (i.e.: power supply)	X	X	-	X	X
Alarms (Managed alarms See page 16)	X	X	-	X	X



Managed alarms

▶ Alarm features

Involved variables and conditions	See "List of variables and conditions with associated alarms"
Management method	See "List of variables and conditions with associated alarms"
Alarm type	Virtual: triggers alarm recording and alerting (web interface/email/text message) Real: triggers alarm recording and alerting (web interface/email/text message) and controls the VMU-O EM accessory module digital output status.
Alarm mode	When either a rising threshold condition or a falling threshold condition is detected
Threshold regulation	0–100% of the range
Hysteresis	From 0 to full scale
Trigger delay	0–3600 s

▶ List of variables and conditions with associated alarms

Source module	Measurement or status
VMU-C EM	Any meter variable, see Data management See page 13
VMU-C EM/ VMU-M EM	No COM1 or COM2 communication Communication problems with local bus, more than one VMU-P EM connected to the local bus, system module settings change, inconsistent programming parameters
VMU-M EM	Input temperature 1 Input temperature 2 Short circuit at probe 1 or probe 2 input, open circuit at probe 1 or probe 2 input, inconsistent programming parameters
VMU-O EM	Inconsistent programming parameters
VMU-P EM	Input temperature 1 Input temperature 2 Analog input Pulse rate input Short circuit at probe 1 or probe 2 input, open circuit at probe 1 or probe 2 input, inconsistent programming parameters



Communication protocols

Introduction

The VMU-C EM module communicates via web interface for set-up, monitoring and system configuration and it transmits data to remote systems (gateway/bridge functions). Different TCP/IP based communication protocols can be used. All protocols are supported by wired and wireless connection and managed on both local network (LAN) and remote one (WAN).

Protocol overview

Protocol	Type	Transmission mode from VMU-C EM	Data	VMU-C EM function
HTTP (web browser)	Standard	Pull	All	Monitoring, configuration
FTP	Standard	Push	All	Gateway
Modbus TCP/IP	Standard	Pull	Variables selection	Gateway
HTTP (API)	Standard	Pull	All variables selection by API	Gateway
DP (Data Push), based on HTTP	Property of CARLO GAVAZZI	Push	All	Gateway

Inbound TCP/IP communication

TCP/IP port number	TCP/IP port description	Purpose
80	HTTP	Access to the internal web-server
52325	SSH	Remote service (reserved to support personnel)

Outbound TCP/IP communication

TCP/IP port number	TCP/IP port description	Purpose
53	DNS	Domain name resolution
123	NTP	Network time services access
21	FTP	Data upload to FTP server
25	SMTP	Email message dispatching
80	HTTP	DP (data push communication)

Modbus TCP communication

TCP/IP port number	TCP/IP port description	Purpose
502 (selectable)	Modbus (TCP)	Modbus TCP data communication: both master and slave



▶ **Notes on FTP protocol**

At the set deadlines, data is grouped in CSV format files and uploaded to the set FTP server. In the event of upload error, the operation is repeated.

▶ **Notes on Modbus TCP slave function**

You can set which variables from which meters are to be transmitted. Configuration parameters (devices' addresses and TCP Modbus mapping) defined on the web server can be exported in PDF or XML format for easier configuration of the Modbus/TCP master.

▶ **Notes on HTTP (web browser)**

The user interface for plant monitoring and system configuration is accessible via a standard web-browser.

▶ **Notes on DP (Data Push)**

Data Push protocol is property of CARLO GAVAZZI and is HTTP based. It guarantees VMUC EM module data synchronization with CARLO GAVAZZI server solutions. For multi-site systems management (Em² Server).

▶ **Notes on Modbus TCP master function**

By means of Modbus/TCP communication the following types of meters can be connected to VMU-C EM:

- a) meters with ethernet interface
- b) meters with RS485 interface + Serial Modbus to Modbus/TCP converter



Web interface

Introduction





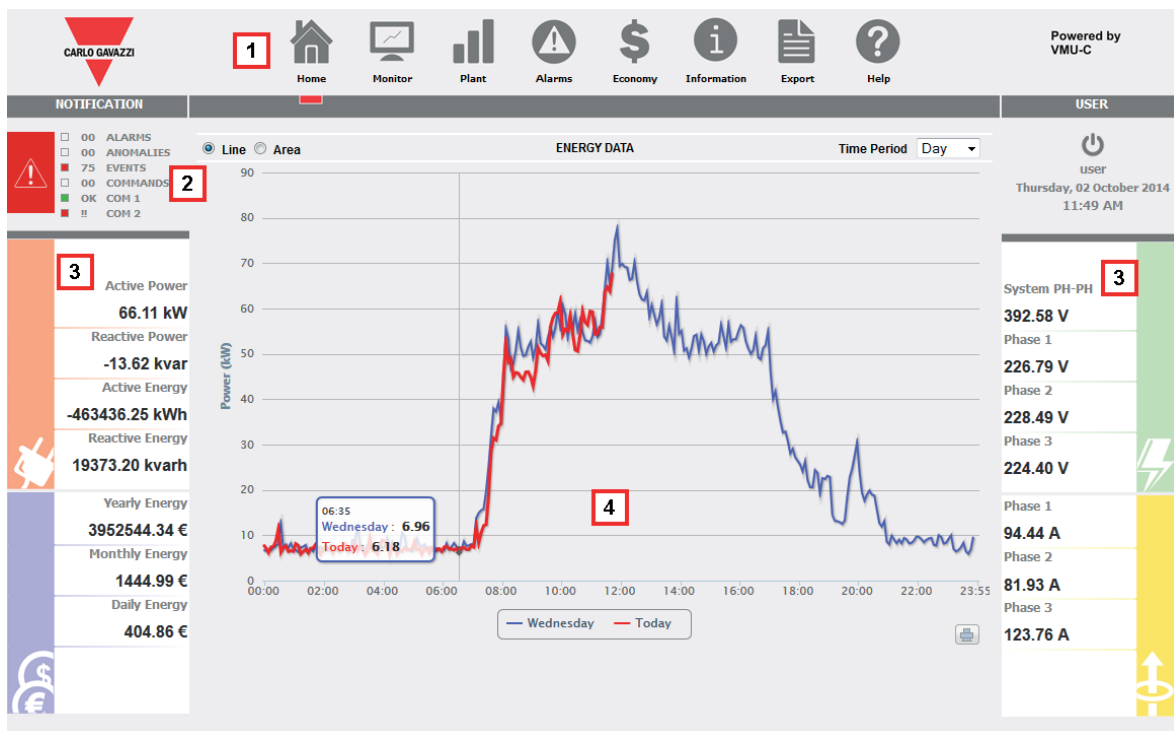

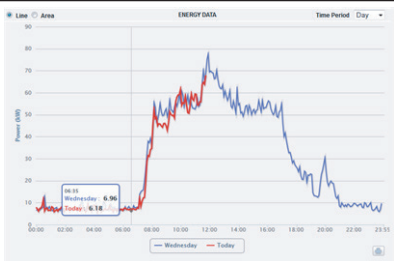

The web interface is accessible with a normal PC browser connected to the VMU-C EM via Ethernet port, mini-USB port or wireless connection with the VMU-D accessory module.

Interface structure

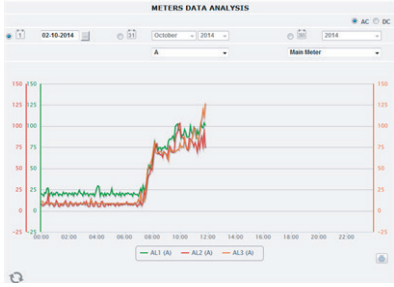



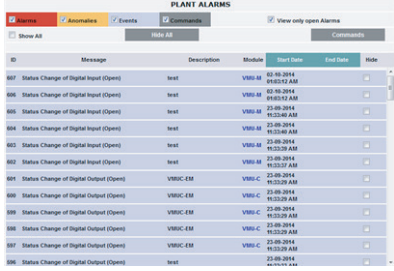



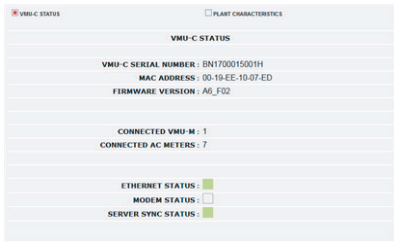

Area	Description
1	Menu bar
2	Alarms and events summary; COM ports communication status
3	System summary information
4	Data charts, configuration settings

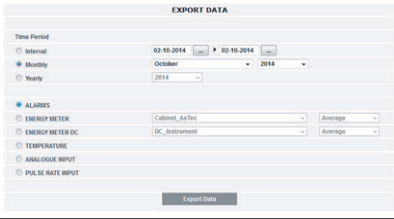
Main functions

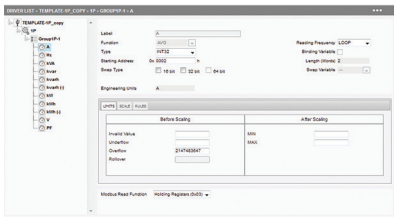
Symbol	Purpose	Example
 <p>Home</p>	<p>Displaying main meter's consumption profile (present trend compared with the past working day/week/month)</p>	
 <p>Monitor</p>	<p>Displaying energy meters data (current, voltage, power, power factor, analog variables) in charts (daily, monthly, yearly).</p>	
 <p>Plant</p>	<p>Displaying: energy consumption data, utility meters totalizers and analog inputs real-time energy meters data customized trends from variable group trends</p>	
 <p>Alarms</p>	<p>Displaying alarms, anomalies, events and recorded commands; manual commands panel</p>	
 <p>Economy</p>	<p>Displaying system costs, calculated based on set tariff data and energy consumption measured by meters</p>	

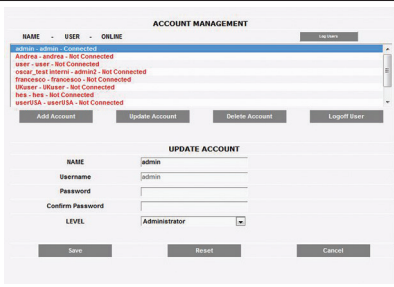

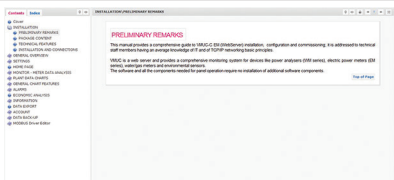
Symbol	Purpose	Example
 <p>Information</p>	<p>Informing of VMU-C EM status. Displaying plant characteristics. Displaying database occupation.</p>	
 <p>Export</p>	<p>Exporting alarms, meter variables and analog variables in a certain period in HTML format compatible with Excel</p>	
 <p>Setting</p>	<p>Setting the entire system, specifically:</p> <ul style="list-style-type: none"> • connections: LAN, VMU-D module; • communication: FTP, HTTP API, Modbus TCP/IP, Data Push; • settings wizard: the VMU-C EM main module, VMU-M EM, VMU-P EM, VMU-O EM accessory modules with relevant inputs, outputs and alarms; • RS485 COM1 and COM2 ports; • mail server to send alarm signals and recurrent .xls files with system data; • recipients list for email and SMS alerts; • firmware update; • energy tariff profiles; • time and date synchronization with NTP server. 	
	<p>Modbus Editor: graphical tool to create, save, edit, download and upload Modbus/RTU and Modbus/TCP drivers to gather variables from whatever Modbus meter.</p>	
 <p>Account</p>	<p>Managing user access to VMU-C EM web server</p>	
 <p>Help</p>	<p>Viewing the web server instruction manual</p>	

Connection Diagrams

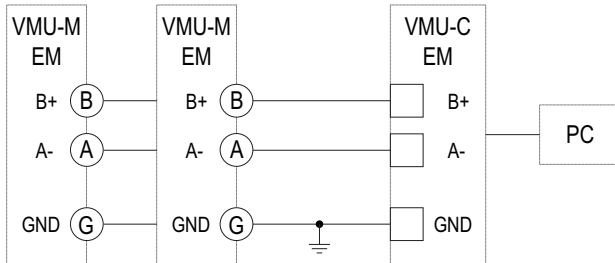

Fig. 1 RS485 COM1 to VMU-M EM modules

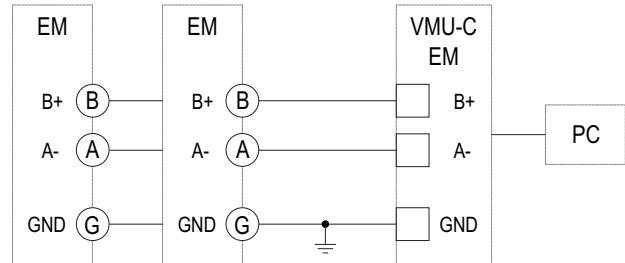

Fig. 2 RS485 COM2 to energy meters

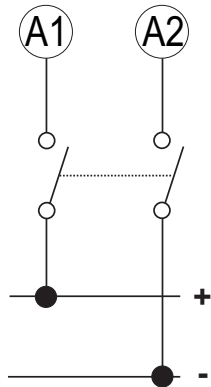

Fig. 3 Power supply

Note Fig. 1

the serial output must be terminated on the last network device by means of a terminating unit according to Modbus standard; check grounding arrangements specification on the official Modbus documentation for proper grounding connections.



References

Further reading

Information	Document	Where to find it
VMU-C EM instruction manual	VMU-C EM Instruction manual	http://www.gavazzi-automation.com/
FTP Push communication protocol	FTP_Service for VMU-C-EM_R1.0.7-communication protocol	Contact Carlo Gavazzi's sales support
HTTP (API) communication protocol	FTP_Service for VMU-C-EM_R1.0.7-communication protocol	Contact Carlo Gavazzi's sales support

Order code

VMUC EM A WS S U X

CARLO GAVAZZI compatible components

Purpose	Component name/code	Notes
Monitor up to 100 VMU-C EM systems (full data synchronization)	Em ² -Server	See relevant data sheet
DC energy meter	VMU-E	
Energy analyzer	EM21, EM210, EM24, EM26	
Energy meter	EM100-300 (family), EM23, EM33, EM270, EM270W, EM271, EM280	
Multifunction meter	WM14	
Power quality analyzers	WM3, WM5, WM30, WM40	
Power transducer	CPT, ET100-300(family)	
VMU-C EM system accessory modules	VMU-D, VMU-M EM, VMU-P EM, VMU-O EM, VMU-MC / -OC, SIU-MBM / -MBC	See following pages

VMU-M EM accessory module



Description

VMU-M EM is a VMU-C EM system accessory module that controls accessory modules via local bus so as to manage analog variables (VMU-P EM) and digital inputs/outputs (VMU-O EM). It communicates with the main VMU-C EM module via RS485 port.

Main features

- Local data and event recording
- Local alarm management
- Accessory modules management: up to one VMU-P EM with analog inputs and up to three VMU-O EM with digital inputs/outputs.
- Two direct inputs (digital or temperature)
- Communication ports: RS485 Modbus RTU and local bus
- 1-DIN size

Main functions

- Record VMU-P EM and VMU-O EM accessory modules data
- Transmit accessory module data via serial communication to the main VMU-C EM module
- Read data from the one digital input or two temperature inputs for local display and alarm threshold management
- Local display of real time variables
- Manage any local alarms

Structure

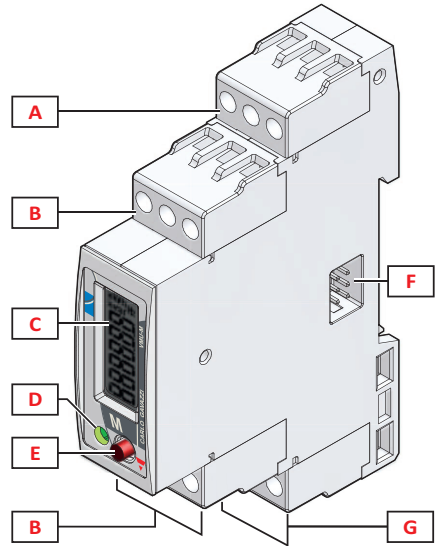

Element	Component	Function
A	RS485 port terminals	Communicating with the VMU-C EM main module
B	Input terminals	Connecting digital or temperature inputs
C	LCD display	Displaying local bus module input variables and some configuration parameters
D	Information LED	Indicating serial communication, power and alarm status
E	Key	Scrolling real time variables and setting some parameters Note: the full configuration is only possible via VMU-C EM main module web interface
F	Local bus port	Connecting up to one VMU-P EM accessory module and up to three VMU-O EM accessory modules to the local bus
G	Power terminals	Powering the module

Features

General

Display capacity	6 digits
Dimensions	1-DIN
Weight	About 100 g (packaging included)
Mean time to failure	MTTF/MTBF: 24.2 years. Test conditions: gf (ground, fixed), 50 °C. Standard: MIL-HDBK-217F.

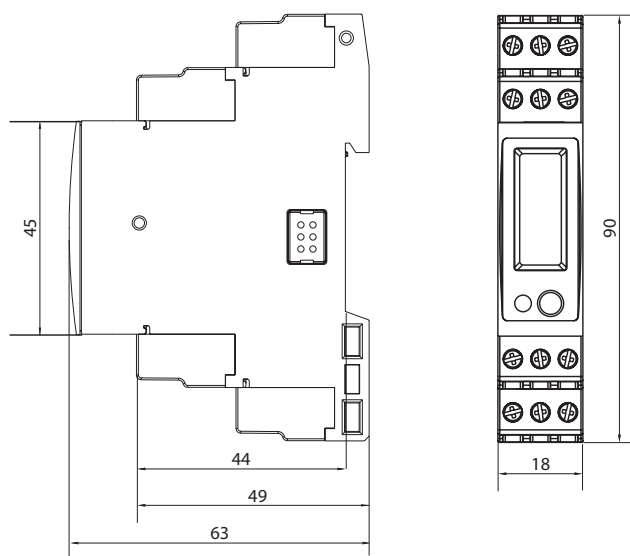

Power Supply

Power Supply	12–28 VDC
Consumption	≤ 1 W

Power supply sizing guidelines, on the basis of connected accessory modules.

VMU-O EM (quantity)	VMU-P EM *(quantity)	Consumption ** (W)	Start-up current (A)	Power supply order code
0	0	2.5	1.5	18 W: SPD 24 18 1B; 30 W: SPM3 24 1
≤ 1	≤ 1	5		18 W: SPD 24 18 1B; 30 W: SPM3 24 1
2 or 3	≤ 1	10.6		60 W: SPD 24 60 1B; SPM4 24 1
Note *: CARLO GAVAZZI wind gauge consumption (p/n DWS-V) included. Note **: VMU-M EM module consumption included.				

Input/output isolation

Module	Type of input/output	Any	VMU-M			VMU-P			VMU-O	
		Local bus	DC power supply	Temperature or digital Inputs: Ch1, Ch2	RS485	Temperature: Ch1, Ch2	Analogue input	Pulse rate input	Digital inputs: Ch1, Ch2	Relay outputs: Ch1, Ch2
Any	Local bus	-	0	0	0	0	0	0	0	4
VMU-M	DC power supply	0	-	0	0	0	0	0	0	4
	Temperature or digital Inputs: Ch1, Ch2	0	0	-	0	0	0	0	0	4
	RS485	0	0	0	-	0	0	0	0	4
VMU-P	Temperature: Ch1, Ch2	0	0	0	0	-	0	0	0	4
	Analogue input	0	0	0	0	0	-	0	0	4
	Pulse rate input	0	0	0	0	0	0	-	0	4
VMU-O	Digital inputs: Ch1, Ch2	0	0	0	0	0	0	0	-	4
	Relay outputs: Ch1, Ch2	4	4	4	4	4	4	4	4	-

Key

- **0:** 0kV inputs / outputs are not insulated. Use insulated probes and free of voltage contacts inputs.
- **4:** 4kV only if the fuse is not present. Remove the fuse only when the disconnecting breaker is switched off. The fuse is only for over-current protection (it has not to be considered as a disconnecting device).

Digital Inputs

Max number of inputs	1
On/Off status detection change	≥ 500 ms
Contact reading voltage	3.3V
Contact reading current	< 1 mA
Contact resistance	≤ 1 kΩ closed contact, ≥ 20 kΩ open contact

Temperature Inputs

Max number of inputs	1
Probe	Pt100 or Pt1000 thermistor
Connection type	2 or 3 wires
Connection compensation	Up to 10 Ω
Range	From -50 to +200 °C / from -58 to +392 °F
Accuracy (Display and RS485) @ 25 ±5 °C, relative humidity ≤ 60%	From -50 to + 200 °C: ±(0.5% RDG + 5 DGT) / from -58 to +392 °F: ±(0.5% RDG + 5 DGT)
Thermal offset	±150 ppm/°C
Engineering unit	°C or °F, selectable



RS485

Communication type	Slave Multidrop, bidirectional (static and dynamic variables)
Connection type	3 wires (A-, B+, Signal GND), maximum distance 1000m
Protocol	MODBUS/JBUS (RTU)
Data	Dynamic (read only): all variables, alarms and events Static (read and write): all configuration parameters
Data format	1 start bit, 8 data bits, no parity, 1 stop bit
Transmission speed	Selectable: 9.6kbps / 19.2kbps / 38.4kbps / 115.2kbps

Local bus port

Compatibility	VMU-P EM and VMU-O EM accessory modules
----------------------	---

Recording on internal memory

Flash	10000 Records (timestamped sets of measurements) + 10000 Events
Recorded information	Analog variables measured from the module and the connected accessory modules. Status changes of: I/Os, power supply, module's configuration and connected accessory modules' configuration. Module configuration and accessory modules configuration.
Variables recording mode	The system calculates the average value of the measured variables in a time interval and saves it. The interval range is configurable from 5 to 60 minutes. The embedded database stores locally the average values for a period which depends on the interval: Interval =5 minutes: period = one month Interval =60 minutes: period= one year
Events and alarms recording mode	Events and alarms are always recorded singularly in a FIFO queue (up to 10000 events).

Connection Diagrams

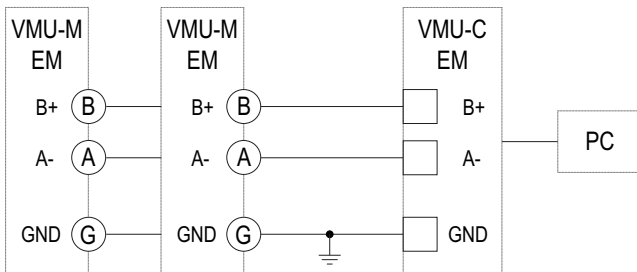

Fig. 4 RS485 Modbus to VMU-C EM main module

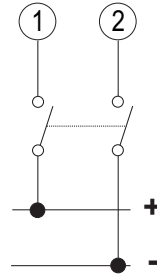

Fig. 5 Power supply

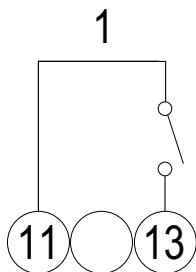

Fig. 6 Digital input 1

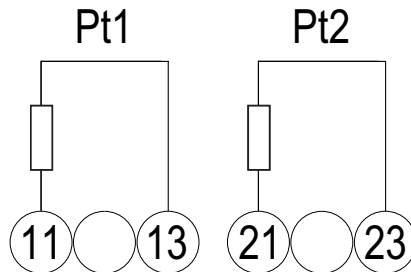

Fig. 7 Temperature inputs 1 and 2
(2 wires)

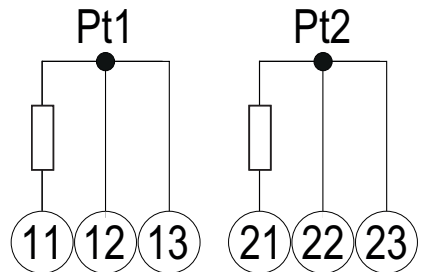

Fig. 8 Temperature inputs 1 and 2
(3 wires)

Note Fig. 4

the serial output must be terminated on the last network device by means of a terminating unit according to Modbus standard; check grounding arrangements specification on the official Modbus documentation for proper grounding connections.



References

Further reading

Information	Document	Where to find it
Modbus (RTU) communication protocol	VMU-M EM - Communication Protocol	Contact Carlo Gavazzi's Support

Order code

 **VMUM 4 A S1 T2 EM**

CARLO GAVAZZI compatible components

Purpose	Component name/code	Notes
Integrate temperature input	IKE20001K	Water-proof temperature probe Pt1000
	TEMPSOL1000	Temperature sensor Pt1000

VMU-O EM accessory module



Main features

- Two digital inputs and two digital outputs.
- Self-powered via local bus.
- 1-DIN size

Main functions

- ON/OFF status detection by means of 2 digital inputs.
- Relay output control by either manual command or event triggering.

Description

VMU-O EM is a VMU-C EM system accessory module that manages two digital inputs and two relay outputs.

It can be connected to the main VMU-C EM module or to the VMU-M EM accessory module via local bus.

Structure

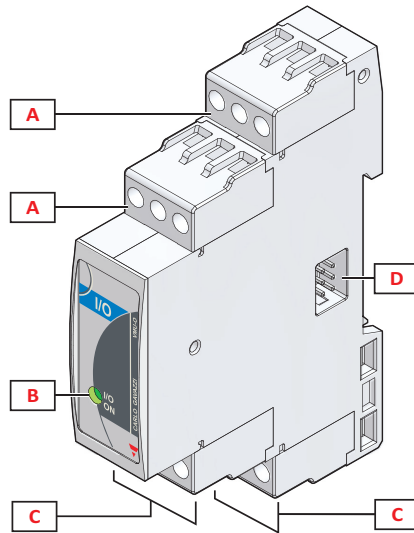

Element	Component	Function
A	Output terminals	Connecting to remote control switches
B	Information LED	Indicating local bus communication status, power supply status, digital input/output status
C	Input terminals	Connecting to digital inputs.
D	Local bus port (right side and left side).	Both sides: connecting to the local bus.

Features

General

Dimensions	1-DIN
Weight	About 100 g (packaging included)
Mean time to failure	MTTF/MTBF: 65.4 years Test conditions: gf (ground, fixed), 50 °C Standard: MIL-HDBK-217F

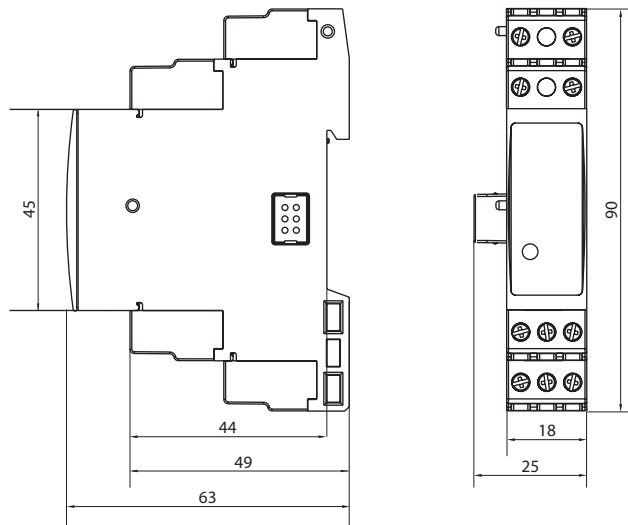

Power Supply

Power	Self-powered via local bus
Consumption	≤ 0.7 W

Inputs

Max number of inputs	2
Type	Digital
On/Off status detection change	≥ 500 ms
Contact reading voltage	3.3 VDC
Contact reading current	< 2 mA
Contact resistance	≤ 300 Ω closed contact, ≥ 10 kΩ open contact

Outputs

Max number of outputs	2
Type	SPST relay AC1: 5A @ 250 VAC AC15: 1A @ 250 VAC
Activation mode	<ul style="list-style-type: none"> • Triggered by an accessory module's alarm condition • Triggered by main VMU-C EM module's alarm condition • Manual control from the web interface • According to a schedule set in the web interface
Initial status	Selectable: normally closed or normally open

Auxiliary bus

Communication function	Slave
Compatibility	Right side: VMU-P EM or VMU-O EM accessory modules Left side: VMU-M master module, VMU-P EM or VMU-O EM module

Connection Diagrams

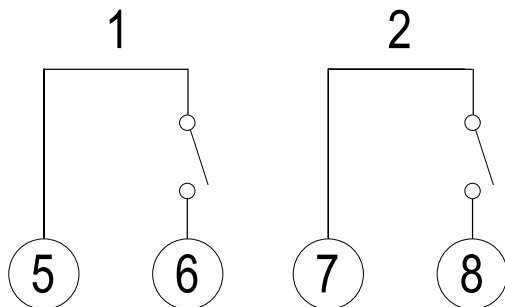

Fig. 9 Digital input 1

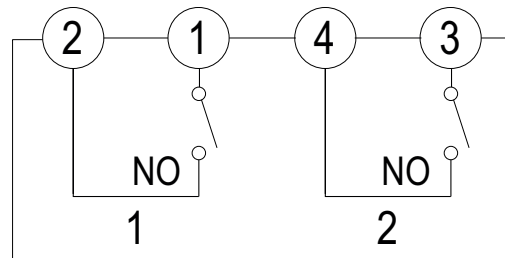

Fig. 10 Digital outputs 1 and 2



References

Further reading

Information	Document	Where to find it

Order code

VMUO X I2 R2 EM

CARLO GAVAZZI compatible components

Purpose	Component name/code	Notes

VMU-P EM accessory module



▶ Main features

- Four inputs: two temperature, one analog and one pulse rate
- Self-powered via local bus
- 1-DIN size

▶ Main functions

- Analogue variables measurement

▶ Description

VMU-P EM is a VMU-C EM system accessory module that manages variables that can affect energy efficiency (i.e.: temperature, irradiance). It can connect to the main VMU-C EM module or to the VMU-M EM accessory module via local bus. It has four analogue inputs.

Structure

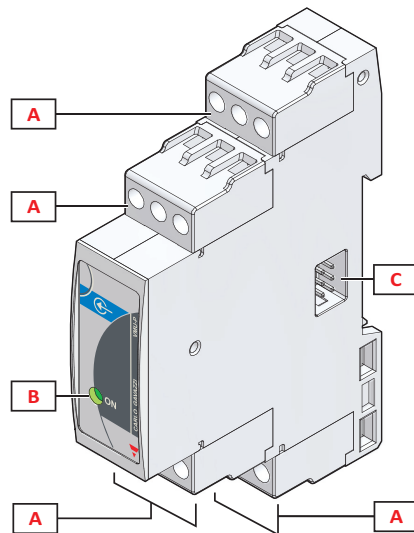

Element	Component	Function
A	Input terminals	Connecting inputs (temperature, 0-20mA or 0-120mV analogue, pulse rate)
B	Information LED	Indicating local bus communication status and power supply status.
C	Local bus port (right side and left side).	Both sides: connecting to the local bus.

Features

General

Dimensions	1-DIN
Weight	About 100 g (packaging included)
Mean time to failure	MTTF/MTBF: 31.7 years Test conditions: gf (ground, fixed), 50 °C Standard: MIL-HDBK-217F

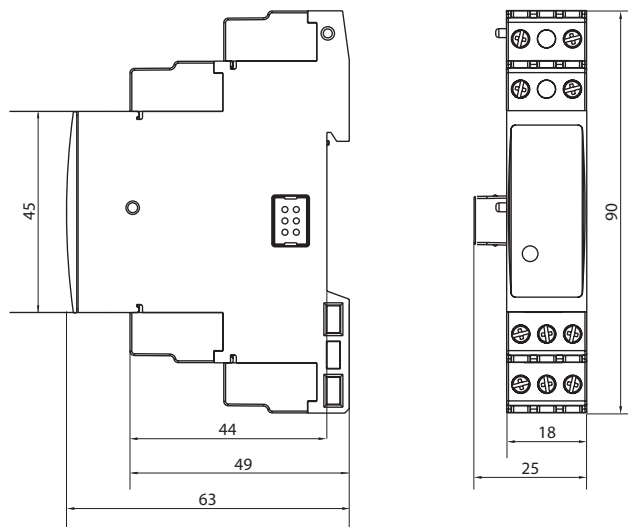

Power Supply

Power	Self-powered via local bus
Consumption	≤ 1.8 W including the pulse rate sensor

Temperature Inputs

Max number of inputs	1
Probe	Pt100 or Pt1000 thermistor
Connection type	2 or 3 wires
Connection compensation	Up to 10 Ω
Range	From -50 to +200 °C / from -58 to +392 °F
Accuracy (Display and RS485) @ 25 ±5 °C, relative humidity ≤ 60%	From -50 to + 200 °C: ±(0.5% RDG + 5 DGT) / from -58 to +392 °F: ±(0.5% RDG + 5 DGT)
Thermal offset	±150 ppm/°C
Engineering unit	°C or °F, selectable

Voltage analogue input (product code: 2TIW)

Max number of inputs	1
Range	3-120 mVDC
Accuracy (Display and RS485) @ 25 ±5 °C, relative humidity ≤ 60%	0-25% f.s.: ±(0.2% RDG + 1 DGT) 25-120% f.s.: ±(0.1% RDG + 1 DGT)
Temperature drift	± 150 ppm/°C
Scaling factor	Measurement input: selectable, 3-150 mV DC Display: selectable, 0-9999 (the decimal point position is also selectable)
Impedance	> 30 KΩ
Overload	Continuous: 10 VDC For 1 s: 20 VDC

Current analogue input (product code: 2TCW)

Max number of inputs	1
Range	0-20 mADC
Accuracy (Display and RS485) @ 25 ±5 °C, relative humidity ≤ 60%	0-25% f.s.: ±(0.2% RDG + 1 DGT) 25-120% f.s.: ±(0.1% RDG + 1 DGT)
Temperature drift	± 150 ppm/°C
Scaling factor	Measurement input: selectable, 0-25 mA DC Display: selectable, 0-9999 (the decimal point position is also selectable)
Impedance	≤ 22 Ω
Overload	Continuous: 50 mADC For 1 s: 150 mADC

Pulse rate input

Max number of inputs	1
Range	0-1000 Hz, work cycle 50%
Accuracy (Display and RS485) @ 25 ±5 °C, relative humidity ≤ 60%	0-25% f.s.: ±(0.2% RDG + 1 DGT) 25-110% f.s.: ±(0.01% RDG + 1DGT)
Temperature drift	± 150 ppm/°C
Scaling factor	Measurement input: selectable 0-999.9 Hz Display: selectable, 0-9999 (the decimal point position is also selectable)
Input impedance	220 Ω
Overload	Continuous: 7 V RMS / 25 mA RMS (AC/DC) For 1 s: 14 V RMS / 50 mA RMS (AC/DC)

Auxiliary bus

Communication function	Slave
Compatibility	Left side: VMU-M EM or VMU-O EM accessory modules. Right side: VMU-O accessory module

Connection Diagrams

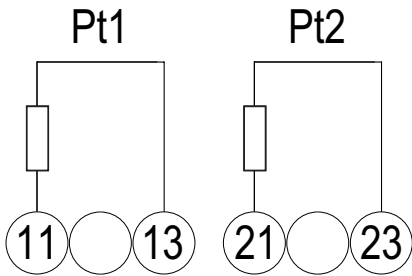

Fig. 11 Temperature inputs 1 and 2 (2 wires)

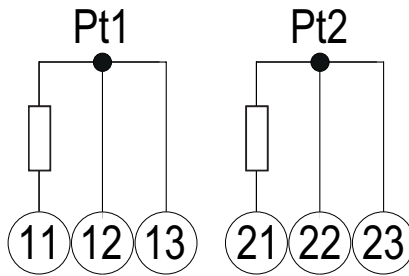

Fig. 12 Temperature inputs 1 and 2 (3 wires)

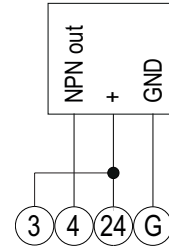

Fig. 13 NPN impulse input (product code: 2TIW)

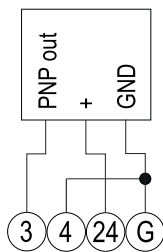

Fig. 14 PNP impulse input (product code: 2TIW)

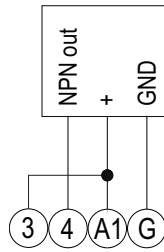

Fig. 15 NPN impulse input (product code: 2TCW)

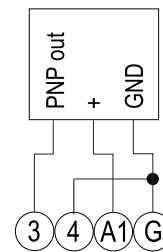

Fig. 16 PNP impulse input (product code: 2TCW)

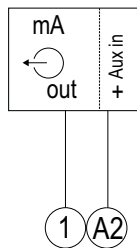

Fig. 17 Analog current input, 2 wires with incoming current (product code: 2TCW)

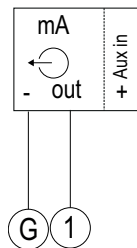

Fig. 18 Analog current input, 2 wires with outgoing current (product code: 2TCW)

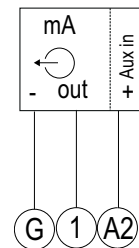

Fig. 19 Analog current input, 3 wires (product code: 2TCW)

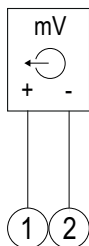

Fig. 20 Voltage analog input (product code: 2TIW)



References

Further reading

Information	Document	Where to find it

Order code

VMUP 2T W X S EM (12 total characters)

Enter the code option instead of

Code	Option	Description
V	-	
M	-	
U	-	
P	-	
2	-	
T	-	
<input type="checkbox"/>	C	20mA analogic measuring input
	I	120mV analogic measuring input
W	-	
X	-	
S	-	
E	-	
M	-	

CARLO GAVAZZI compatible components

Purpose	Component name/code	Notes
Integrate temperature input	IKE20001K	Water-proof temperature probe Pt1000
	TEMPSOL1000	Temperature sensor Pt1000
Solar irradiance sensing	PVS2A1WXC PVS1V PVS1A	2nd Class Pyranometer for certified solar irradiance sensing

VMU-D accessory module



Description

VMU-D is a VMU-C EM accessory module, that provides compatible Carlo Gavazzi devices with a reliable and cost effective way to connect to Internet by using mobile networks via dongle modem.

Main features

- Compatible with VMU-C family of products
- Mobile Internet connection
- Compatible with USB dongle modems
- Watchdog features to prevent common mobile network hassles

Main functions

- Remote access by Internet when a wired connection is not available
- Plug'n play configuration
- Reliable operation
- SMS alerting
- SMS commands



Structure

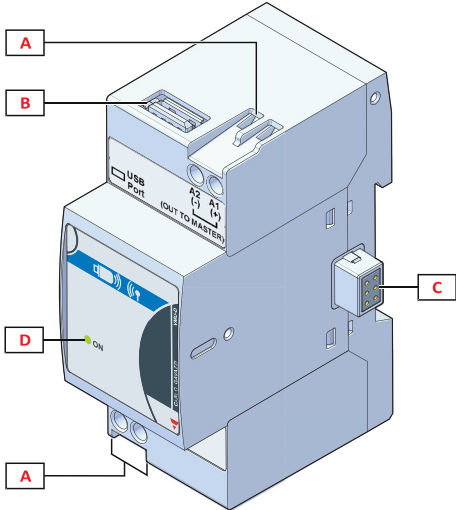

Element	Component	Function
A	Power supply	Power supply connection block (IN, bottom/OUT, top) (Min./Max. screws tightening torque: 0.4 Nm / 0.8 Nm)
B	USB connector	Connecting dongle modem
C	Local bus port	Connecting to the VMU-C main module
D	Power information LED	LED (green), 2 status Steady off, power OFF Steady on, power ON

Note: USB CONNECTION is active if the Dongle is connected AND the VMU-C is connected to the VMU-D AND the power supply is connected AND no USB peripheral connected to VMU-C's USB port



Features

General

Dimensions	2-DIN
Weight	< 600 g (packaging included)
Mean time to failure	MTTF/MTBF: 26 years Test conditions: gf (ground, fixed), 50 °C Standard: MIL-HDBK-217F

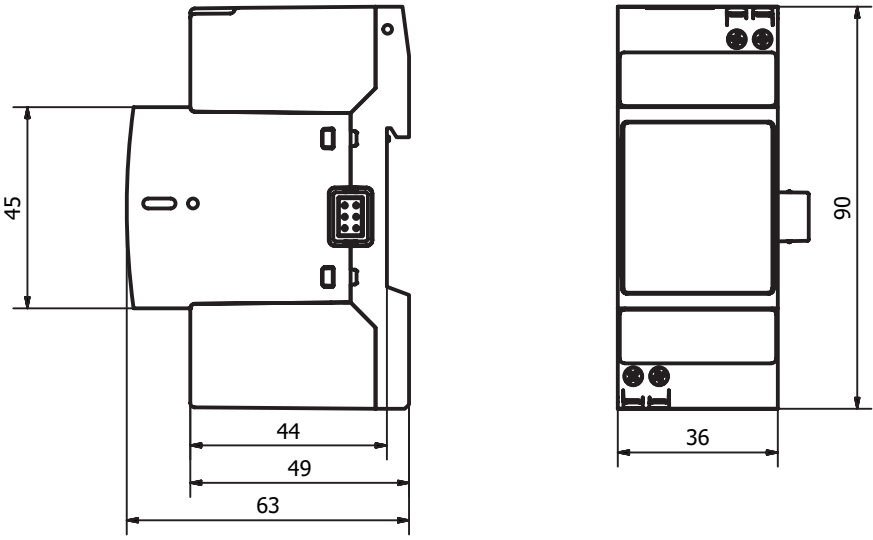

Power Supply

Power Supply	12-28 VDC
---------------------	-----------



Ports

Auxiliary bus

Local bus connection	Master Proprietary VMU-C connector
----------------------	------------------------------------

USB

Type	USB 2.0 Standard-A receptacle
Terms of use	Mechanically compatible with standard USB dongle modem in the market

Connection Diagrams

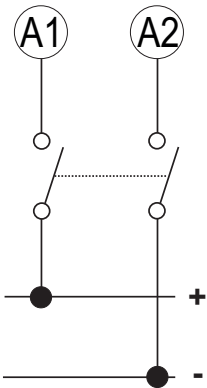

Fig. 21 Power supply



References

Further reading

Information	Document	Where to find it

Order code

VMUDAUDCX

CARLO GAVAZZI compatible components

Purpose	Component name/code	Notes
Web Server	VMU-C EM	
Web Server	VMU-C PV	
Modem	HUAWEI MS2131 (3G) HUAWEI E3531 (3G) Multitech QuickCarrier® USB-D (3G) TeleOrigin RB900L (3G, 4G) Digicom 8D5782DG4 - USB (4G)	Third party

VMU-MC and VMU-OC



Pulse concentrator



Description

VMU-MC is a pulse concentrator that makes totalizers available to master systems (i.e.: VMU-C EM) via Modbus RTU protocol. Furthermore, it controls up to three VMU-OC accessory modules via local bus to integrate from 2 to a maximum of 11 digital inputs. Each VMU-OC module controls up to three digital inputs, connected via local bus and powered by VMU-MC.

Benefits

- **Modularity.** The VMU-MC module can be used singularly or with the addition of VMU-OC modules (from 1 to 3) based on the number of meters to be monitored.
- **Compact and retrofit products.** VMU-MC and VMU-OC are suited for small spaces and existing systems with pulse output meters.
- **Ease of installation.** The modules can be mounted on DIN rail.
- **Termination block.** Supplied in the VMU-MC package, it easily and quickly terminates the RS485 port on the last device in the line.
- **Free specific software.** The system is compatible with UCS software that has a simple and intuitive interface. The software and subsequent updates are free.
- **Configuration ease and flexibility.** The units of measure and pulse weight of each input can be configured from UCS. Configurations can also be set off-line, saved and retrieved from UCS at any time.
- **Elementary diagnostics.** Correct system operations can be checked from UCS and the display.
- **Easy integration with VMU-C EM.** The UCS software is able to generate the driver to easily import input configurations in the VMU-C EM master.

Applications

Designed for commercial, residential and industrial applications, guarantee rapid installation with few easy connections.

They are particularly indicated for:

- retrofit applications in existing distribution panels where data is to be collected from pre-existing pulse output meters
- utility type meters with pulse outputs

All consumption data (i.e. electricity, gas, water, heat) of a commercial or industrial building or a residential home can be integrated in the same VMU-C EM master, enabling the following:

- precise cost allocation
- implementation of energy efficiency improvement policies
- check on correct operation and use of systems and machinery

Main functions

- Read and concentrate pulse output meter data
- Transmit data read via serial communication to VMU-C EM or another master

Architecture

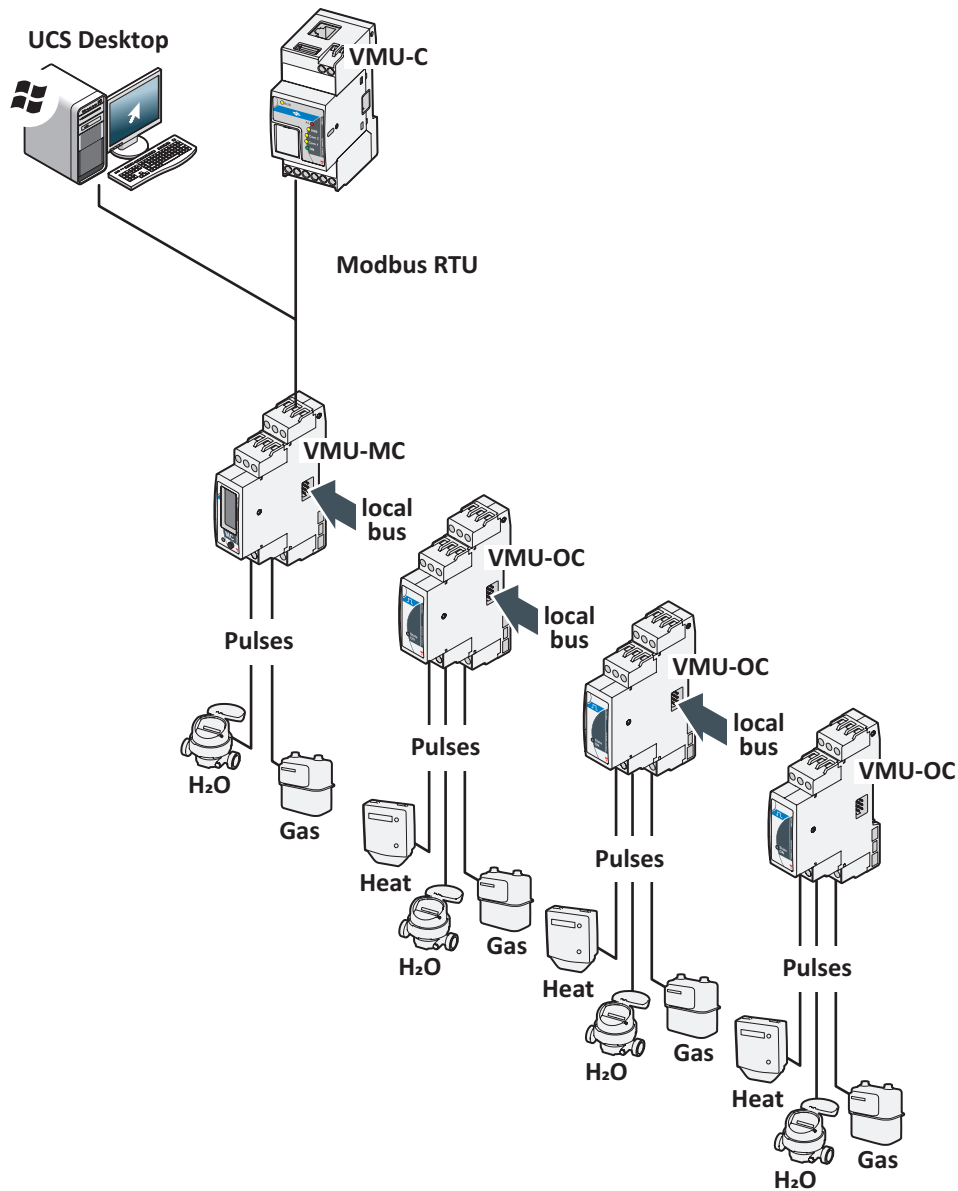

Main features

- Up to 11 S0 digital inputs (2 integrated and up to other 9 via VMU-OC modules)
- Up to 3 VMU-OC modules connected via local bus and powered by VMU-MC
- Input function: remote input status reading / tariff management / pulse counting
- Communication ports: RS485 Modbus RTU and local bus
- 6 digits LCD display (for VMU-MC only)
- Dimensions: from 1 to 4 DIN modules according to the number of VMU-OCs
- Configurable from UCS

Layout (VMU-MC)

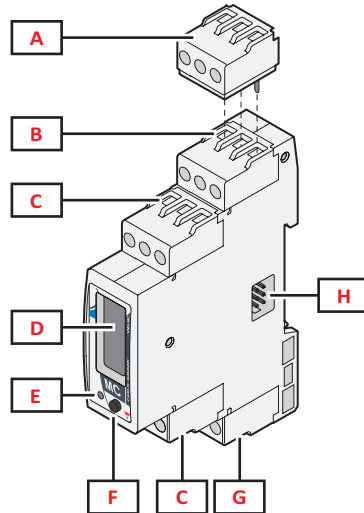

Area	Description
A	Termination block for serial output of the last device in the line
B	Terminal block for RS485 port for communication with the master
C	Digital input terminal block
D	LCD display
E	LED to indicate device status
F	Button to scroll the display and set communication parameters
G	Power supply terminal block
H	Local bus port for VMU-OC module connection

Layout (VMU-OC)

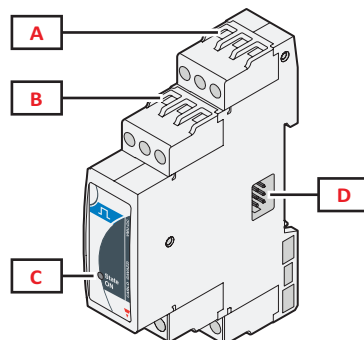

Area	Description
A	Digital input terminal block (+)
B	Digital input terminal block (-)
C	Multipurpose LED: device status identification of the module selected by VMU-MC
D	Local bus ports right side: connection to any VMU-OC module left side: connection to VMU-MC or another VMU-OC module

Features

General

Material	Noryl
Protection degree	Front: IP40 Terminals: IP20
Terminals	Cable section: 1.5 mm ² Torque: From 0.4 to 0.8 Nm
Pollution degree	2
VMU-MC Insulation	Not insulated among power supply, inputs and RS485 port
VMU-OC Insulation	Inputs not insulated Towards power supply, VMU-MC inputs, RS485 port and other VMU-OC modules: 4 kV rms, 50 Hz/1' Reinforced insulation, overvoltage cat. III, systems with voltage up to 300 V grounding
Mounting	On DIN rail
Dimensions (mm)	1-DIN See figures
Display	6 digits LCD
Weight	About 100 g (packaging included)

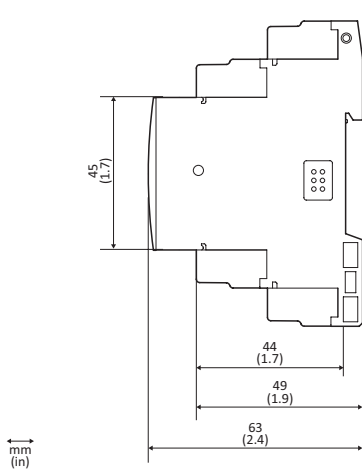

Fig. 1 VMU-MC dimensions

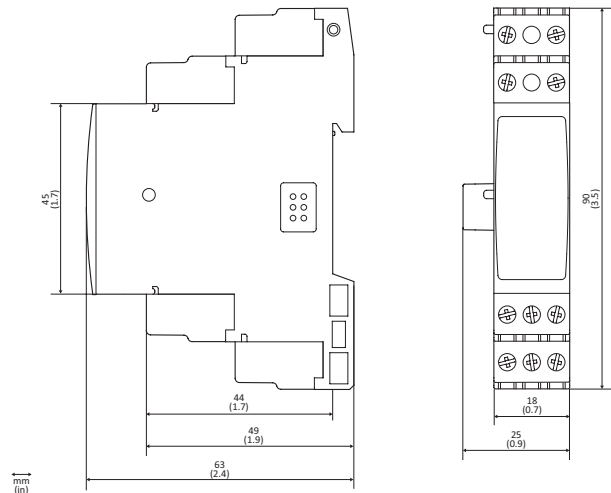

Fig. 2 VMU-OC dimensions



Environmental specifications

Operating temperature	From -25 to +55 °C/from -13 to +131 °F
Storage temperature	From -30 to +70 °C/from -22 to +158 °F

NOTE: R.H. < 95% non-condensing @ 40 °C .



Conformity

Directives	2011/65/EU (Electric-electronic equipment hazardous substances) 2014/30/EU (EMC - Electro Magnetic Compatibility) 2014/35/EU (LVT - Low Voltage)
Standards	Safety requirements for electrical equipment for measurement, control and laboratory use: IEC61010-1/UL61010-1 Devices with pulse outputs: IEC62053-31, S0 class B Electromagnetic compatibility (EMC) - emissions and immunity: EN61326-1.
Approvals	 

Power supply

Power supply	From 15 to 24 V dc, Cl. 2
Consumption	Maximum 100 mA
Connector	Screw terminals

Digital inputs

Number of inputs	VMU-MC: 2 VMU-OC: 3
Type	S0, class B according to EN62053-31 ($I_{max} < 15 \text{ mA}$, $U_{max} \leq 15 \text{ V}$)
Configuration parameters	Pulse weight Units of measure: kWh, kvarh, kVAh, kJ, kcal, m3, Nm3, h, pcs, kg Normal input status (normally open or normally closed) Minimum pulse duration filter (configurable from 5 ms to 300 ms)
Frequency	Maximum 100 Hz
Functions	Pulse counting Input status reading* Tariff management* (VMU-MC only) Note *: not managed by VMU-C EM

RS485 port

Communication type	Multidrop, bidirectional (static and dynamic variables)
Connection type	Screw terminals 3 wires
Protocol	Modbus RTU
Data	All
Data format	1 start bit, 8 data bits, no parity/even/odd, 1 or 2 stop bit
Configuration parameters	Modbus address (from 1 to 247) Baud rate (9.6 / 19.2 / 38.4 kbps) Parity (None/ Odd/ Even) Stop bit (1 or 2)

**Display**

Type	LCD
Refresh time	<1 s
Information displayed	Status Totalizer (without decimals) Any active tariff
Utilities	View/edit communication parameters Check connected meter status operation and the state of each input

Connection Diagrams

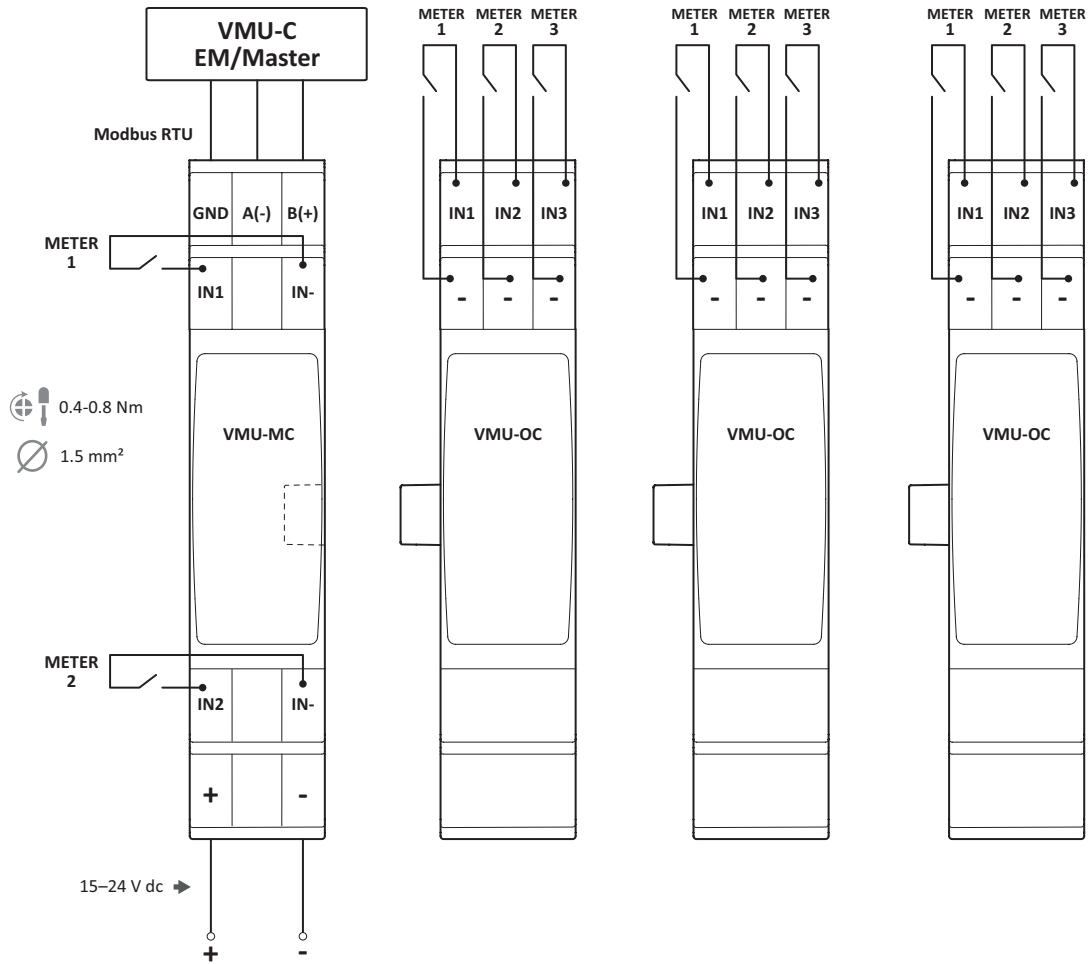



References

▶ Further reading

Information	Document	Where to find it
Installation, operating and maintenance instruction	Instruction manual - VMU-MC	
Installation, operating and maintenance instruction	Instruction manual - VMU-OC	
Datasheet	VMU-C EM Datasheet	
Modbus register map decryption	Modbus protocol	

▶ CARLO GAVAZZI compatible components

Purpose	Component name/part number	Notes
Configure VMU-MC and generate the driver for VMU-C EM	UCS configuration software	Available for free download at: www.productselection.net
Monitor data from several devices	VMU-C EM	See relevant datasheet
Power VMU-MC	SPM1241	See relevant datasheet
Connect to VMU-MC from PC via USB/RS485 converter	SIU-PC3	See relevant datasheet

▶ How to order VMU-MC

Code	Description
VMU-MC AS1I2EM	Pulse concentrator with two integrated digital inputs

▶ How to order VMU-OC

Code	Description
VMU-OC AI3XXEM	Module with three digital inputs to integrate VMU-MC

По вопросам продаж и поддержки обращайтесь:

Алматы (7273)495-231	Казань (843)206-01-48	Новокузнецк (3843)20-46-81	Смоленск (4812)29-41-54
Архангельск (8182)63-90-72	Калининград (4012)72-03-81	Новосибирск (383)227-86-73	Сочи (862)225-72-31
Астрахань (8512)99-46-04	Калуга (4842)92-23-67	Омск (3812)21-46-40	Ставрополь (8652)20-65-13
Барнаул (3852)73-04-60	Кемерово (3842)65-04-62	Орел (4862)44-53-42	Сургут (3462)77-98-35
Белгород (4722)40-23-64	Киров (8332)68-02-04	Оренбург (3532)37-68-04	Тверь (4822)63-31-35
Брянск (4832)59-03-52	Краснодар (861)203-40-90	Пенза (8412)22-31-16	Томск (3822)98-41-53
Владивосток (423)249-28-31	Красноярск (391)204-63-61	Пермь (342)205-81-47	Тула (4872)74-02-29
Волгоград (844)278-03-48	Курск (4712)77-13-04	Ростов-на-Дону (863)308-18-15	Тюмень (3452)66-21-18
Вологда (8172)26-41-59	Липецк (4742)52-20-81	Рязань (4912)46-61-64	Ульяновск (8422)24-23-59
Воронеж (473)204-51-73	Магнитогорск (3519)55-03-13	Самара (846)206-03-16	Уфа (347)229-48-12
Екатеринбург (343)384-55-89	Москва (495)268-04-70	Санкт-Петербург (812)309-46-40	Хабаровск (4212)92-98-04
Иваново (4932)77-34-06	Мурманск (8152)59-64-93	Саратов (845)249-38-78	Челябинск (351)202-03-61
Ижевск (3412)26-03-58	Набережные Челны (8552)20-53-41	Севастополь (8692)22-31-93	Череповец (8202)49-02-64
Иркутск (395)279-98-46	Нижний Новгород (831)429-08-12	Симферополь (3652)67-13-56	Ярославль (4852)69-52-93
Россия (495)268-04-70	Киргизия (996)312-96-26-47	Казахстан (7172)727-132	